

# OPERATION MANUAL

MBM Air Suction Folder

Model 1800S



MBM Corporation

Version: 06A01(MBM)

161104

# Introduction

Thank you for purchasing MBM Model 1800S Air Suction Paper Folder. You should receive many years of reliable service from this machine. Compact and easy to use, 1800S Folder is sure to streamline your paper folding tasks, saving you valuable time. Please read the Operation Manual thoroughly before using this machine.

# Contents

Safety Instructions .....	4
1. Specifications.....	7
2. Accessories .....	8
3. Part Names.....	10
4. Designation and Functions of Operations Panel.....	12
5. Setup after opening transport packing .....	13
1) Setting of the Paper Ejection Table .....	13
2) Setting of Table 1 .....	14
3) Setting of Table 2 .....	15
4) Setting of the Auxiliary Paper Feed Table .....	17
5) Connecting Power Cable.....	18
6) Turn on the Power Switch. ....	19
6. Preparation of Paper .....	20
7. Initial setting .....	21
1) Prepare 200 sheets of Ledger(11x17”), 24lbs,Bond Paper .....	21
2) Turn on Folding Machine.....	21
3)-6) Set up paper on Feed Table.....	21-22
7) Leave no gap between Paper Leading Edge and Machine's Front Paper Stopper Wall .....	22
8) Skew Correction is done by two methods .....	23
(a) By Feed Angle Adjustment Dial (Drum-Feed-Roller).....	23
(b) By Skew Adjustment Knob at Feed Table .....	23
9) Set L Stopper at the rear end of the Paper.....	23
10) Close the Top Cover. ....	23
11) Trial Air Blow and Suction.....	24
(a) Air Blow Strength Adjustment for sheet separation.....	24
(b) Paper Floating Height Adjustment relative to Suction Belt.....	25
(c) Adjustment of Suction Air Strength.....	25
(d) Approximate Guidance of Suction Air and Paper Feed Table Height .....	26
12) Selection of Folding Pattern .....	27
13) Selection of Folding Speed.....	27
14) Setting Speed.....	27
15) Test Folding.....	27

16)	Other Control and Functions .....	28
(a)	Paper Ejection Roller .....	28
(b)	How to use Interval Function.....	28-29
(c)	Double Feed Detection or No-Detection.....	29
8.	Standard folding of standard-size paper .....	30
1)	Selection of Folding Pattern.....	30
2)-3)	Select Folding and Set Speed .....	30
4)	Set number of sheets to fold .....	30
(a), (b)	Count Down and Count Up.....	30
5)	Start Folding.....	30
6)	Folding Line (distance) Adjustment.....	30
9.	Standard Folding of No-Standard-Size Paper.....	31
1)	Measure paper length .....	31
2)-4)	Input paper length.....	31
5)	Paper Setting, Speed Selection, Air Control and Feed Table Skew Control.....	32
6)	Set number of sheets to fold.....	32
7)	Start Folding.....	32
8)	Folding Line (distance) Adjustment.....	32
10.	Control (Adjustments) .....	33
1)	Fine Adjustment for folding line distance by Table 1 or 2 .....	33
2)	Stopper position Guide of Table 1 or Table 2 for each fold pattern .....	34
3)	Skew Control Guidance Chart for 6 folding patterns by Feed Angle Adjustment Dial and Feed Table Angle.....	35-40
4)	Separator Rubber Height.....	41
11.	Memory.....	41
1)	Fold Position Memory of No-Standard Sized Papers .....	41
2)	Fold Position Memory of Standard Sized Papers .....	42
3)	Clearing Memory .....	43
4)	Clearing all the memorized patterns .....	43
12.	Check Lamps, Error Codes and Troubles .....	44
1) - 7)	Location Finder, Error Codes and Symptom.....	44-46
13.	Troubleshooting and Cleaning.....	47
1)	Troubleshooting of Paper jam .....	47
2)	Cleaning of Sensors.....	48
3)	Cleaning of Fold Roller and Paper Feed Belt .....	49-50
14.	Other Adjustable Functions .....	51
1)	Weight Arm.....	51
2)	Adjustment of Base Plate of Table 2.....	51
3)	Folding Roller Pressure (Press Power) Adjustment .....	52

# Safety Instructions

## Definition of Symbols and Notes

The following names and signs stand for possible dangers.



### Danger

This symbol stands for immediate danger. Disregarding these instructions may cause severe injury.



### Caution

This symbol stands for a potentially dangerous situation. Disregarding these instructions may lead to injuries or damage to property.

<h2>Danger</h2>	
	Make sure that the machine is electrically grounded to prevent electrical shock.
	Operate the machinery within reasonable voltage range. There is a risk of electrical shock or fire if a higher or lower voltage is used, or if an electric current is utilized with a frequency not within the range stated above.
	Do not place any object on top of this machine. There is a risk of electrical shock or fire if water or any foreign object enters the machine.
	Handle the power cord with care. There is a risk of electrical shock or fire if the cord is damaged, broken, or placed under a heavy object.
	Do not insert or remove the power plug when water is present.
	Do not remove the cover of this machine. There is a risk of an electrical shock.
	Do not reconfigure the electronics of this machine. There is a risk of an electrical shock or fire.
	Do not operate the machine if it is emitting smoke or a strange odor. Turn off the machine, unplug it from the outlet and contact your dealer.
	Do not operate the machine if the power cord is generating heat or emits a strange smell. Turn off the machine, unplug it from the outlet and contact your dealer.
	If a foreign object enters into the machine, turn off the power switch and unplug the power plug, then consult your dealer.
In the event of a thunderstorm, unplug the machine.	

<h2>Caution</h2>	
	Keep hair, clothing, and jewelry away from the machine while operating. Serious injury may result.
	Do not put the machine on an unstable or slanted surface. Doing so may cause the machine to drop or fall over, causing damage and possible injury.
	Store and operate the machine in a clean, dust-free environment with low humidity. Avoid areas with high moisture, extreme temperatures and excessive dust, as these conditions may cause machine failure or electrical shock. Operate the machine at the temperature of 5 degrees to 35 degrees C.
	Be sure to grasp the power cord by the plug when unplugging it from the electrical outlet. Not doing so may cause damage to the cord and possible electrical shock or fire.
	Be sure to pull the power plug out of the electric outlet before moving the machine. Not doing so may cause damage to the cord and possible electrical shock or fire.
	Unplug the power plug from the electrical outlet when this machine is not in use.
	The socket-outlet shall be installed near the equipment and shall be easily accessible.

## WARNING 1

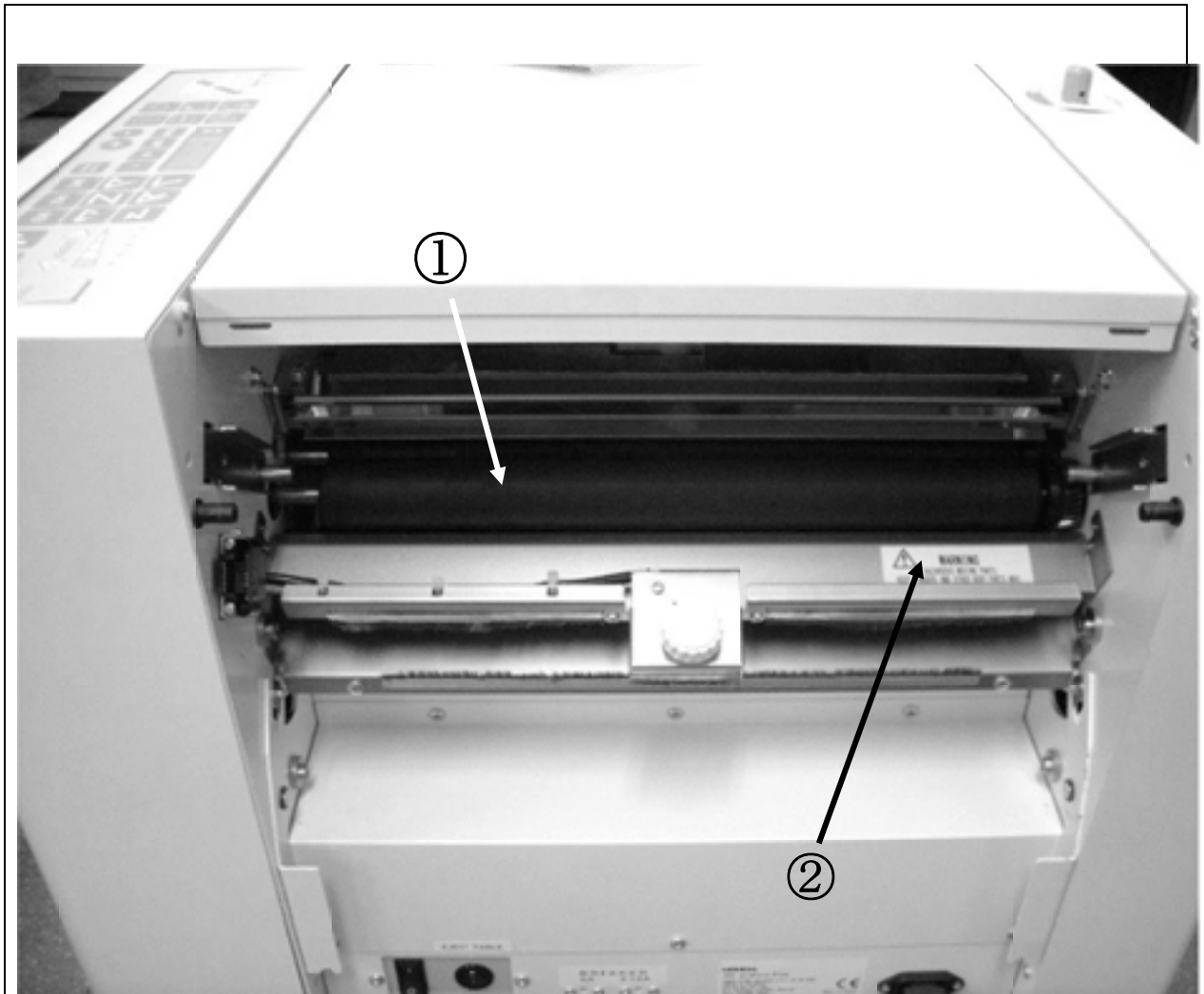

- ① : Moving Parts
- ② : Warning Label

**WARNING**  
HAZARDOUS MOVING PARTS  
KEEP FINGERS AND OTHER BODY PARTS AWAY.

## WARNING 2

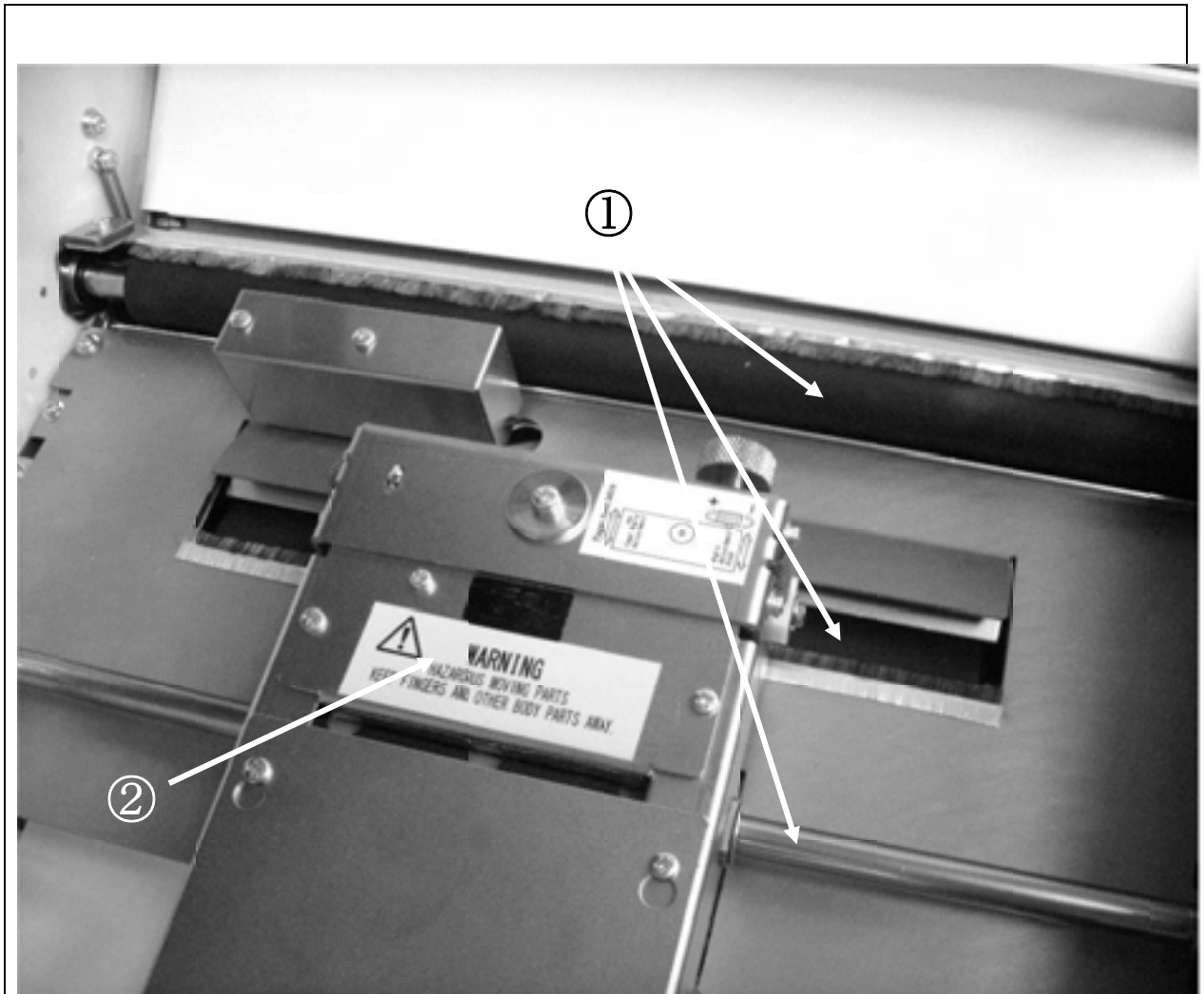

- ① : Moving Parts
- ② : Warning Label



**WARNING**  
HAZARDOUS MOVING PARTS  
KEEP FINGERS AND OTHER BODY PARTS AWAY.

# 1. Specifications



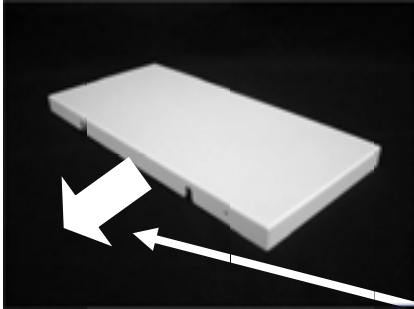
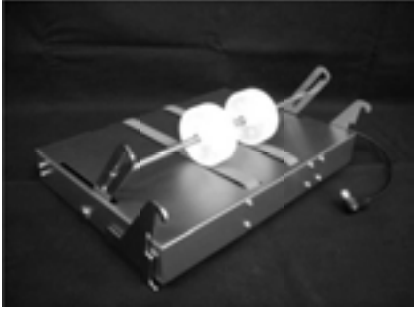

Model:	MBM 1800S Air Suction Paper Folder
Paper sizes:	4.7" × 8.2" – 12.9" × 19.2"
Paper weight:	Bond 13.9 to 42.5 lbs (Bond 42.5 – 61.1 lbs for single fold with limited paper)
Paper quality:	Offset paper, Coated Paper
Folding patterns:	Single, Letter, Zigzag, Double Parallel, Fold-out and Gate* (*21.6-42.5 lbs Bond and Gate is limited to certain papers/prints)
Folding dimensions:	Maximum folding dimensions Table 1: 14.4" Table 2: 9.6"
	Minimum folding dimensions Table 1: 2.0" Table 2: 2.0" Smallest adjustment increment: 0.003"
Paper feed system:	Belt Suction Feed system
Maximum capacity:	2.9", or 800 sheets, Bond 20 lbs
Folding speed:	Max 18,000 sheets per hour (single fold, Letter) Speed adjustable in 5 steps.
Control system:	Automatic setting by built-in microcomputer
Other functions:	Automatic paper size detector (Letter, Legal and Ledger) Four-digit counter with addition/subtraction modes 18 memories for standard fold patterns (fine adjustment) 3 special memories for out of standard paper sizes Skew correction Double Feed Sheet Detection by Ultra-Sonic Sensor: Detects any double fed sheets such as White, Printed, Black and Transparent. Error Detection: Empty Feed, Empty Paper, Stacker full, Paper Jam and others. Interval Function Folding Roller manually removable without tool for cleaning Folding Pressure Adjustment (Thicker to Thinner Paper) Table #2, Base Plate Adjustable (Thicker to Thinner Paper)
Noise	88dB, 20 lbs Bond, double parallel at the highest speed level 5
Power source:	100 thru 240 VAC, 2.6A /245W, 50/60Hz
Dimensions:	51.2"(W) × 23.1"(D) × 25.6"(H) (in use)
Weight:	Net: 160 lbs Shipping (Approx.): 200 lbs
Options:	Perforation/Scoring Unit (12.5" × 17.7") Large Capacity Stacker (Long Delivery) Interceptor for Table #2 (Used to fold double size Letter)

## 2. Accessories

After un-boxing, make sure that the following accessories are present. Please contact your local dealer immediately if anything is missing.

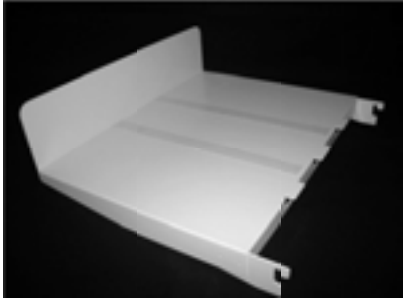
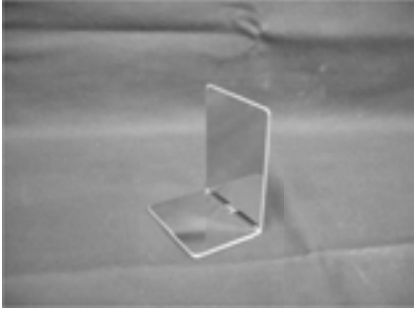
Accessories	Quantity	Figure
Table 1	1	
Table 2	1	
Auxiliary Paper Feed Table	1	 <div data-bbox="1278 1249 1430 1509" style="border: 1px solid black; padding: 5px; display: inline-block; vertical-align: middle;"> <p>Toward Main Paper Feed Table</p> </div>
Paper Ejection Table and Ejection Roller	1	

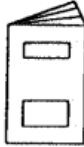
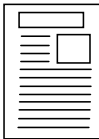

<p>Auxiliary Paper Ejection Table</p>	<p>1</p>	
<p>L Stopper Guide</p>	<p>1</p>	
<p>Paper Ejection Control Plate</p>	<p>1</p>	
<p>Power cord</p>	<p>1</p>	
<p>Weight Arm</p>	<p>1</p>	
<p>Operation Manual</p>	<p>1</p>	
<p>Basic Operation Manual</p>	<p>1</p>	

### 3. Part Names

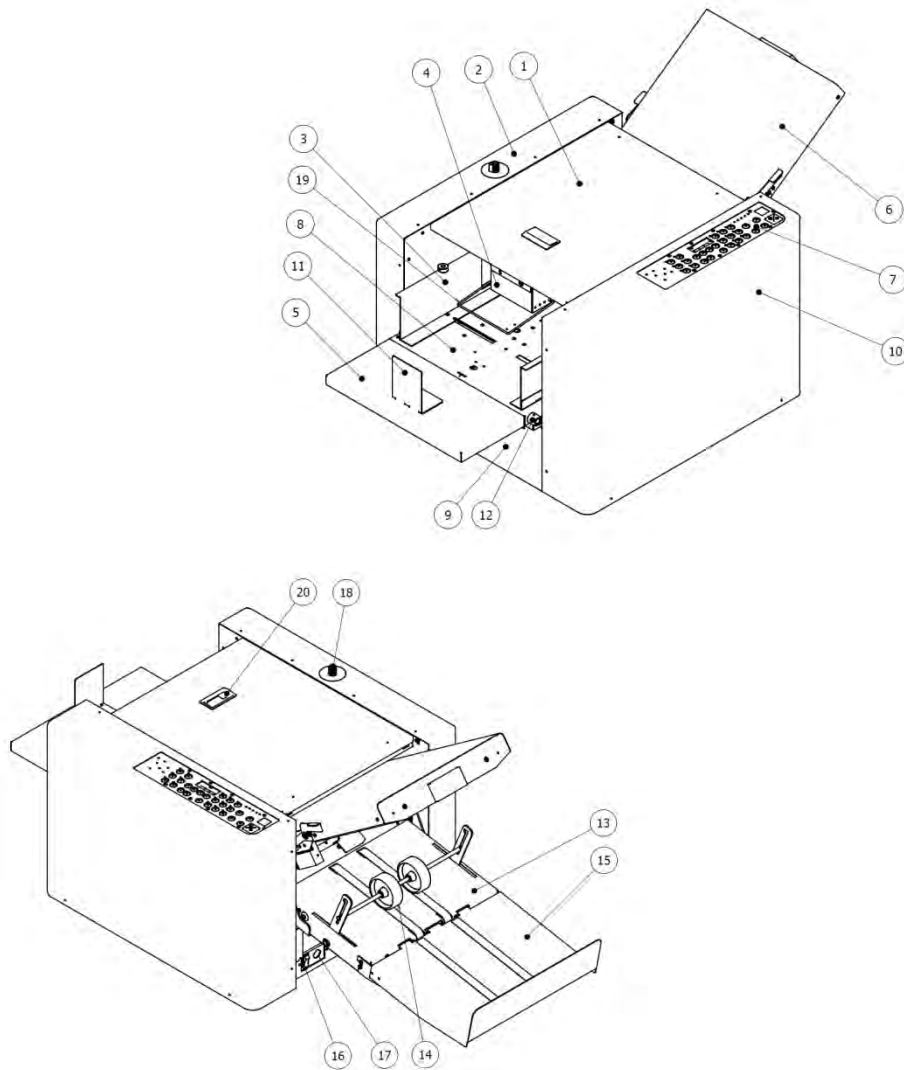

	Name	Number	Name
①	Top cover	⑫	Skew Adjustment Knob
②	Left side cover	⑬	Paper Ejection Table
③	Paper Guide(Left & Right )	⑭	Paper Ejection Roller
④	Paper Height Detection Sensor	⑮	Auxiliary Paper Ejection Table
⑤	Auxiliary Feed Table	⑯	Power Switch
⑥	Table 1	⑰	Paper Ejection Table Socket
⑦	Operation Panel	⑱	Air Adjustment Knob
⑧	Paper Feed Table	⑲	Weight Arm
⑨	Door for Table 2	⑳	Top cover Knob
⑩	Right side cover	*	Table 2
⑪	L Stopper guide		

Table 2 is set under the Paper Feed Table in the machine, which you find when opening the door ⑨ for the table 2.



Upper Cover is open to adjust belt feeder assembly.

Error Code Chart

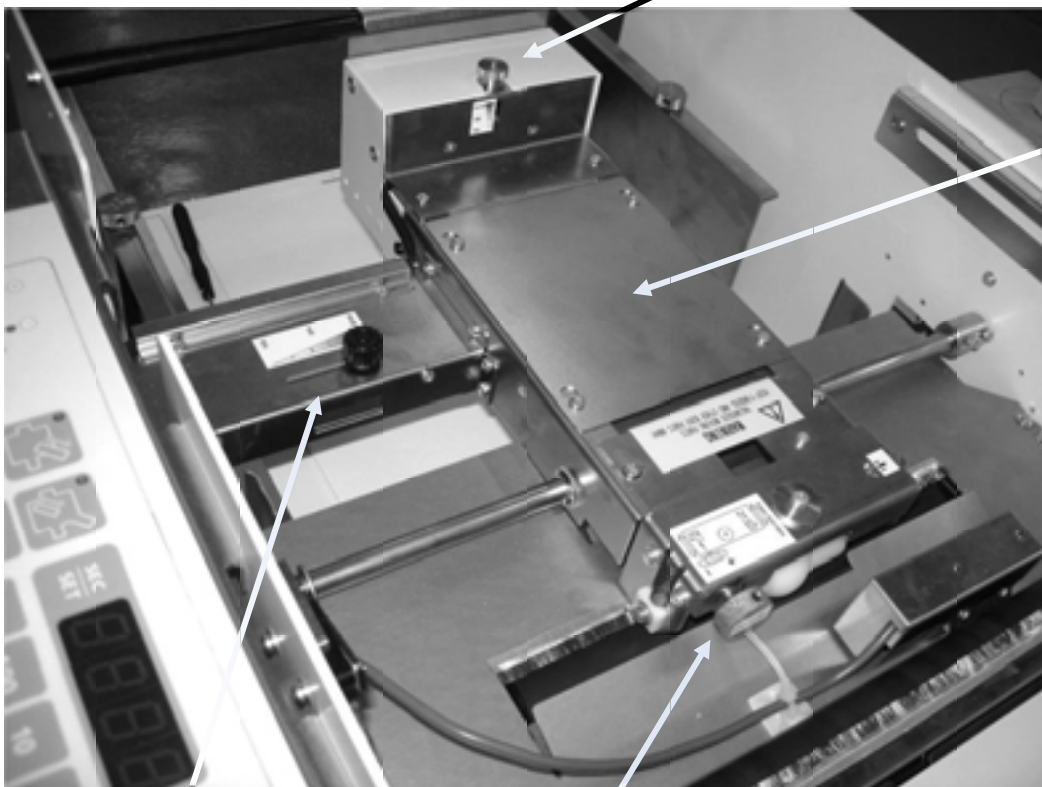

Paper Floating Height Adjuster

Belt Feeder Assy

Suction Air Adjuster

Feed Angle Adjustment Dial

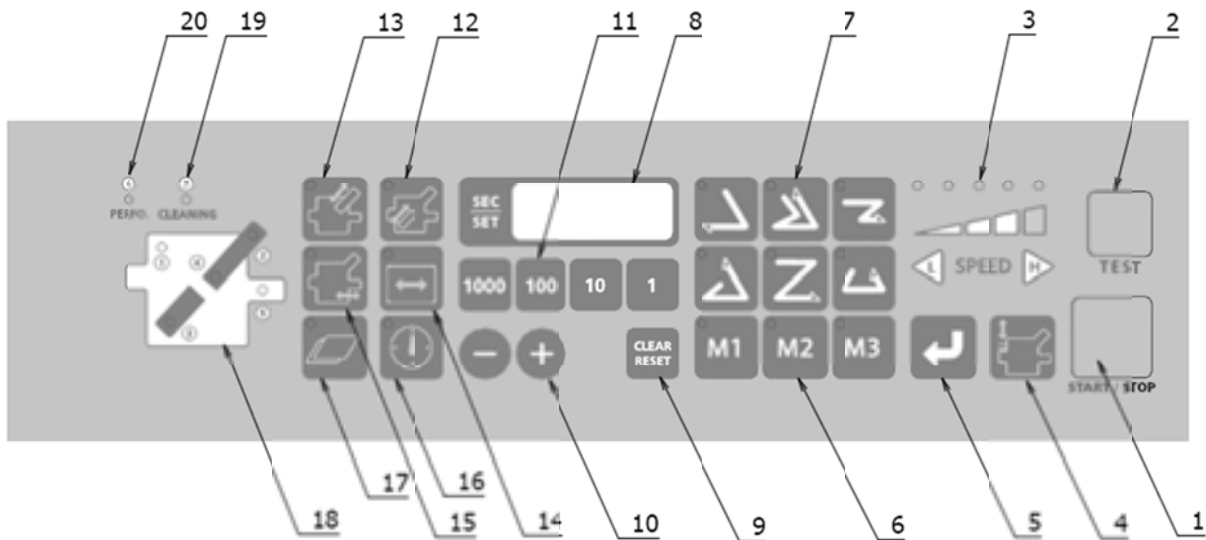

#### 4. Designation and Functions of Operations Panel

No.	Designation/Indication	Function
①	START/STOP key	Starts and stops machine.
②	TEST key	1) <u>Test</u> folds two sheets without counting. 2) Also used for <u>test blow</u> without folding (pressed more than 2 seconds until buzzer sounds.)
③	Speed adjustment key	Select 5 speed.
④	Paper feed table up/down key	Moves up and down the Paper Feed Table
⑤	Store key	Memorize fold position after adjustment is done.
⑥	Memory 1/2/3 key	Memorize three special fold types.
⑦	Fold type key	Select 6 fold types and store job routine.
⑧	Counter	Shows the number of sheets, position of the stopper of Table 1 and 2, and paper size.
⑨	Clear/Reset key	Clears the counter / resets after an error.
⑩	+/- key	Use for adjusting position of the stopper of Table 1 and 2, the position of paper ejection roller, and inputting paper length
⑪	Numerical key	Use for inputting the number of sheets to be folded, length of non-standard size paper, factors of interval function and others.
⑫	Table 2 stopper move mode key	Use to adjust Table 2 Stopper position.
⑬	Table 1 stopper move mode key	Use to adjust Table 1 Stopper position.
⑭	Paper length input mode key	Use to input paper length for non standard norm paper.
⑮	Paper ejection roller move key	Use to adjust position of Paper Ejection Roller.
⑯	Interval key	Sets time and number of interval function during folding work.
⑰	Double Feed Error Detection key	Sets double feed error detection ON/OFF.
⑱	Trouble Locating Map	
	①②③④⑤	Indicates location of trouble.
	In case of Double Feed	①④⑤ lamps flash at the same time. Display indicates E-13.
⑲	Cleaning lamp	Indicates when cleaning of the FEED section (belt, roller) is necessary. It lights every 10,000 sheets of folding. Can disable this function. Refer detailed section.
⑳	Perforation mode lamp	Indicates when the optional perforating unit is installed.

## 5. Setup after opening transport packing

### 1) Setting of Paper Ejection Table

Install Paper Ejection Table to the main machine body.

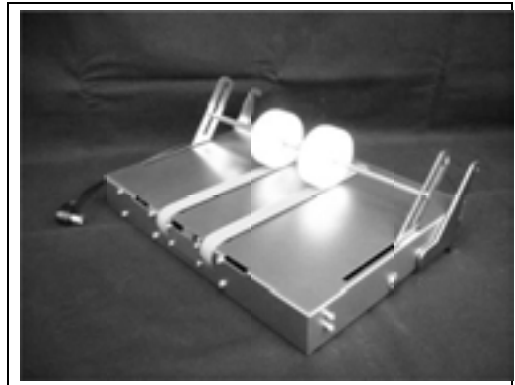

Install the Table by putting its hook on the guide pins at two sides.

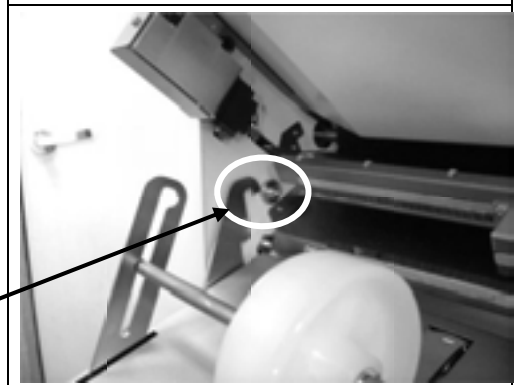

Guide Pin

Make sure that the hooks are securely hung on the guide pins.

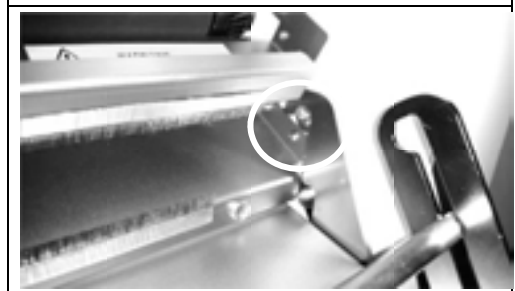

Place Paper Ejection Control Plate underneath Ejection Roller Shaft and fix by Thumb Screw.

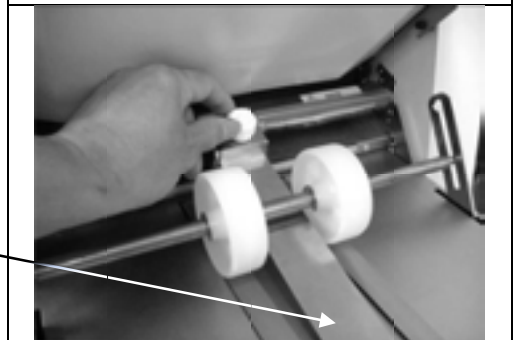

Paper Ejection Control Plate

Auxiliary Paper Ejection Table

Install Auxiliary Paper Ejection table to the Paper Ejection Table.



Plug in Electric Connector of Paper Ejection Table to the machine.



Bracket

## 2) Setting of Table 1

Check that Set Lever on both sides are positioned in UNLOCK. Slide in Bracket (RH & LH) of Table 1 slowly into diagonal direction along the guides of the main machine body.

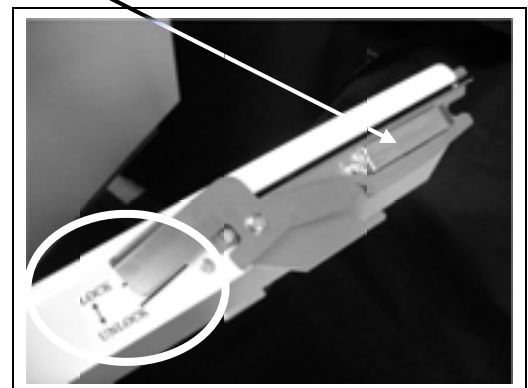

Table 1 Bracket Guide

The Table 1 connector is located on Operation Panel side. Give utmost care not to damage the Electric Connector when installing the Table 1.

Electric Connector for Table 1

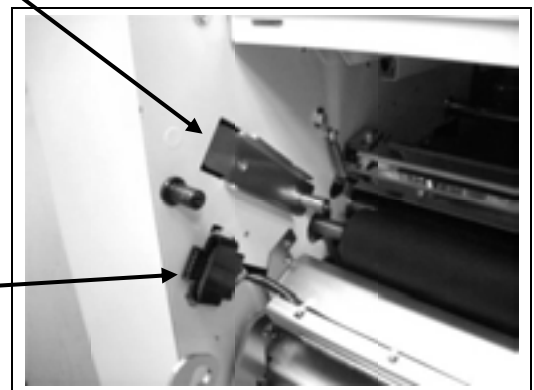
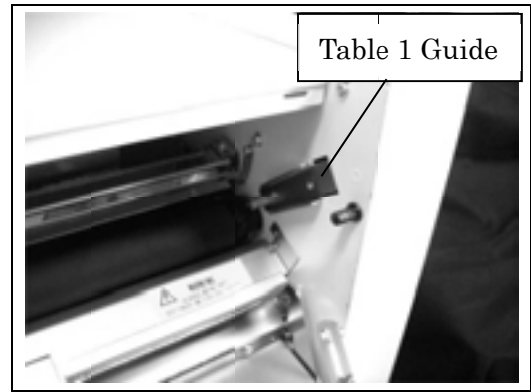
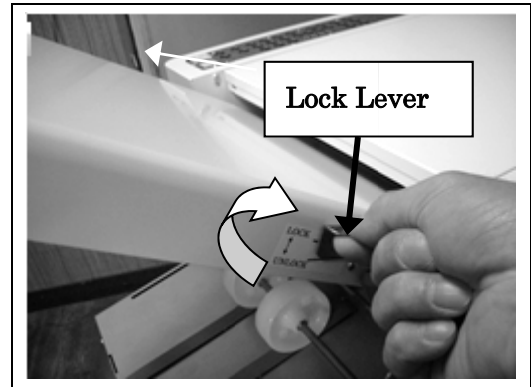

Table 1 Bracket Guide on the opposite side wall of Operation Panel.



Install Table 1 to the main machine body securely and fix it using Lock Levers located on both sides. (Move top of the lock lever to the direction of arrow as shown in the right figure.)



### 3) Setting of Table 2

Make sure that no paper is loaded on Paper Feed Table, and press the Paper Feed Table Up and Down Key so as to raise the table until it stops at the uppermost point.

For installing or removing table 2, do it after raising the paper feed table up to the highest point using the paper feed table Up and Down Key.

In case the paper feed table is located at any place other than the lowermost point, if the paper feed table Up and Down Key is pressed, it moves down to the lowermost point. Therefore, press the paper feed table Up and Down Key again to raise it to the uppermost point.

In case the paper feed table is located at the lowest point, if the paper feed table Up and Down Key is pressed, the table moves up.

If the paper feed table Up and Down Key is pressed while the paper feed table is in operation, the paper feed table stops motion.

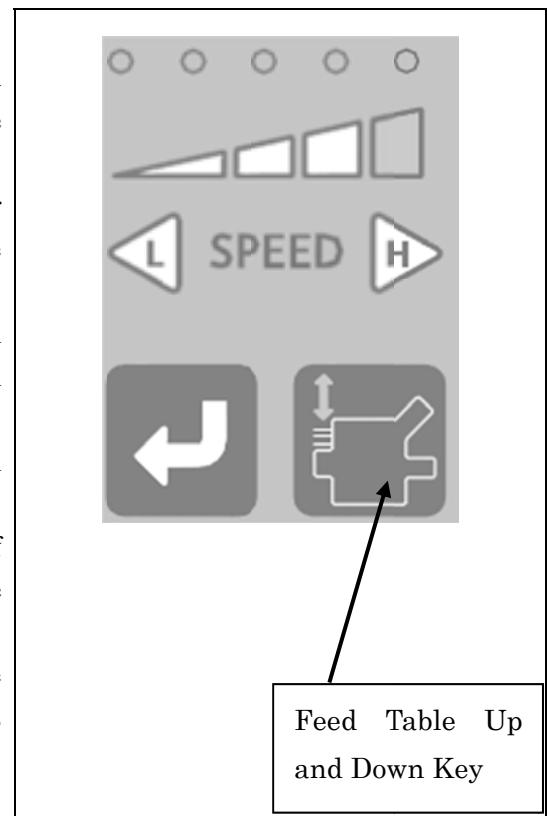

Open the door for the Table 2.

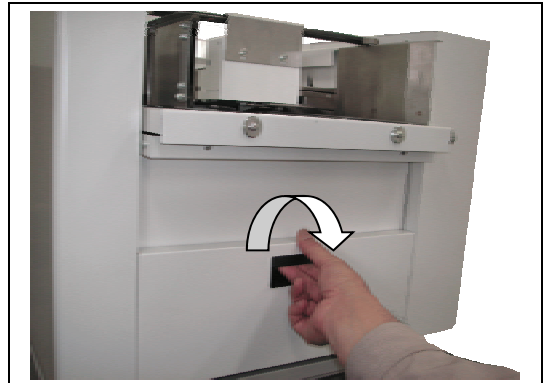

There you see the Flat Set-Up Base for Table 2.

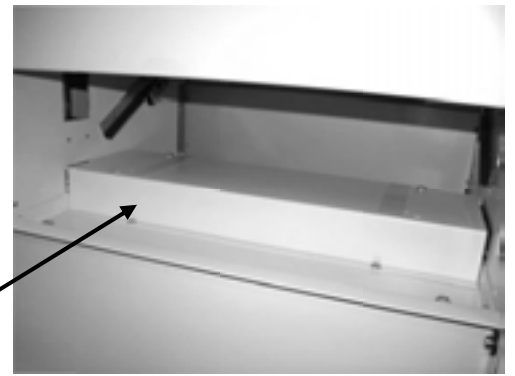

Table 2 flat set up base

Place Table 2 just flat on the Set-Up Base.





Push in the rear side of Table 2 until it is caught by recess of Guide Rails. You feel click here.



Plug in the electric connector for Table 2.



Close the Door for the Table 2.

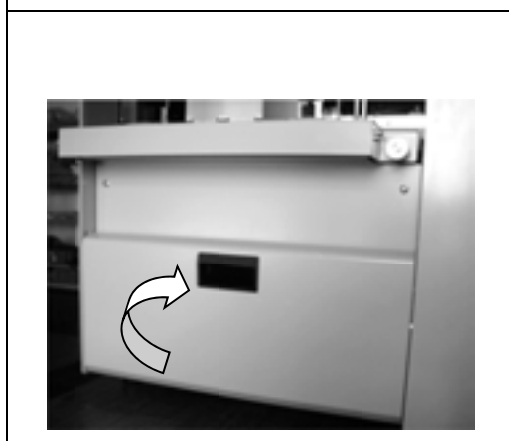

#### 4) Setting of the Auxiliary Paper Feed Table

Push in Guide Slots of Auxiliary Paper Feed Table into 2 Flange Pins of Paper Feed Table.

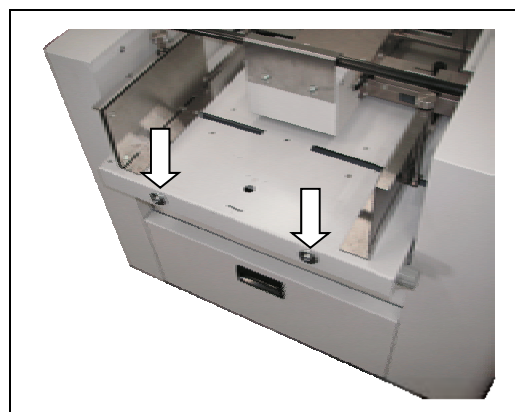

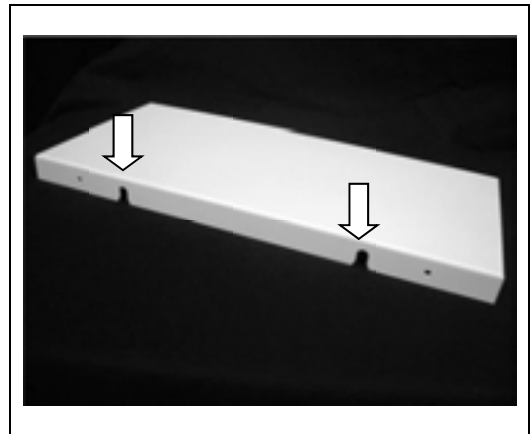

After Auxiliary Paper Feed Table is set, make sure the Paper Feed Table and Auxiliary Paper Feed Table Surface is flat.

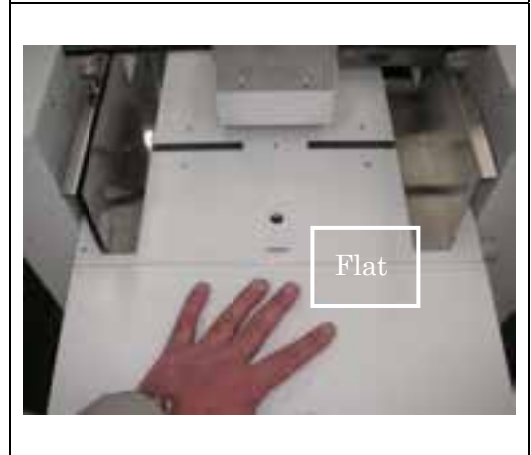
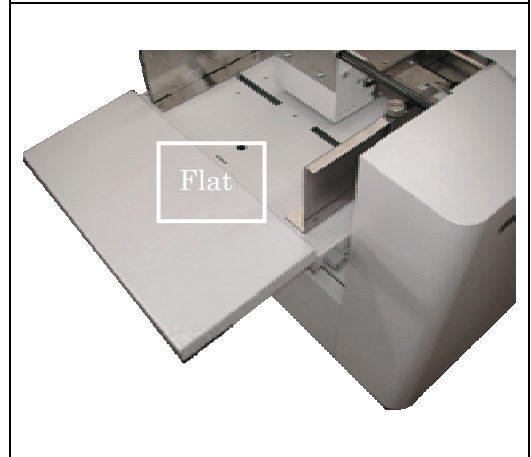

### 5) Connecting Power Cable

Insert the power cable into electric inlet of machine and the other end to electric power outlet.

#### Caution:

Make sure to connect to the electric power outlet equipped with ground terminal.

Do not use a power cable other than the one provided.

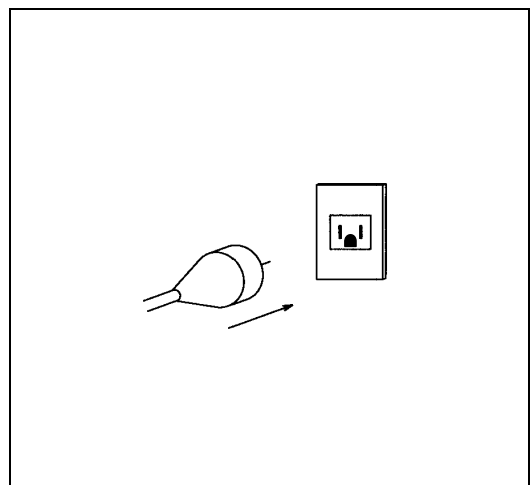

**6) Turn on the Power Switch.**



## 6. Preparation of Paper

Fan out the paper sufficiently.

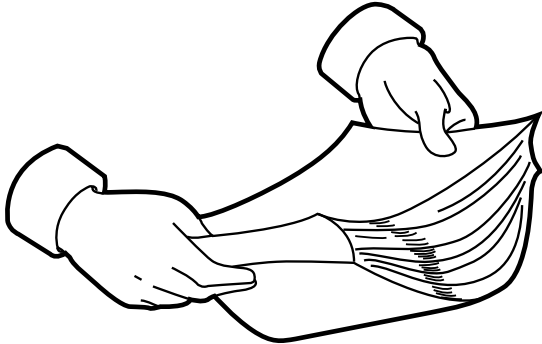

Jog the paper. If paper edges are bent or warped, straighten them up..

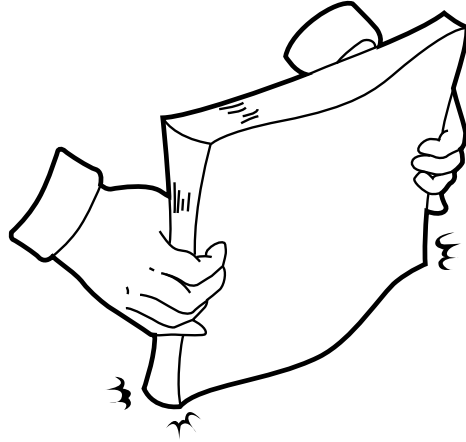

Use dry paper.

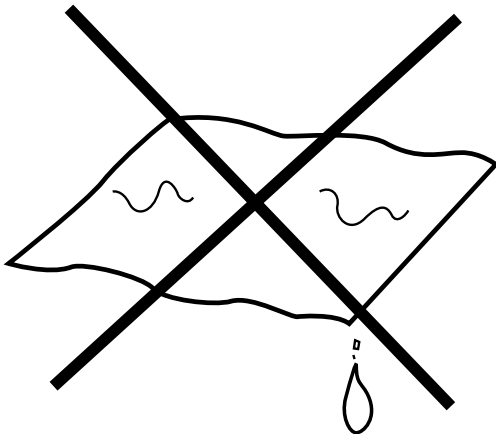

Keep the stacking capacity.

**Max. 800 sheets (20 lbs)**



It should be noted that when paper stack as thick as 2.9" or more is placed on the Paper Feed Table, smooth feed may not be available. Also it may cause damages to the machine.

## 7. Initial Setting

To start using this machine, for ease of practice, explanation is described, wherever applicable, for Ledger paper size and 24 lbs Bond paper with Single Fold at medium speed 3. This introductory operation intends to make the user become familiar with operation of the machine so that it will be easier for applied applications.

After abovementioned practice, it is recommended to use other paper sizes, paper weights, folding patterns and different speeds.

1) **Prepare approximately 200 sheets of Ledger(11"×17"), 24 lbs,Bond Paper. Paper corners must be cut exactly 90 degree angles.**

2) **Turn Power Switch on.**

3) **To set the paper, press Feed Table up/down Key and place the Feed Table at lowest position.**

Note: When setting sheets of paper on the Paper Feed Table, press the Paper Feed Table Up/Down Key. In case the Paper Feed Table is located at any place other than the lowest point, it moves down to the lowest point once.

In case the paper feed table is located at the lowest point, if the Paper Feed Table Up/Down Key is pressed, the table moves up.

If the Paper Feed Table Up/Down Key is pressed while the paper feed table is in motion, the table stops at the position.

Note: In case of installing or removing Table 2, do it after raising the Paper Feed Table up to the highest point using the Paper Feed Table Up/Down Key.

4) **Open Top Cover.**

5) **Widen Paper Guides, and load the 200 sheets of Ledger Paper in portrait on Paper Feed Table which is already connected with Auxiliary Feed Table.** Paper should be fanned out and jogged well prior to loading. Standard norm paper sizes within this machine specifications are automatically recognized by the Folder, i.e., in this case as Ledger.

Note: Set up Paper while lifting Weight Arm slightly.

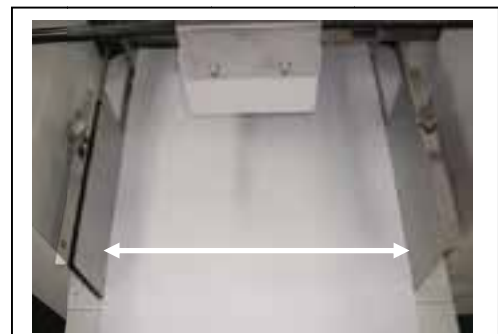
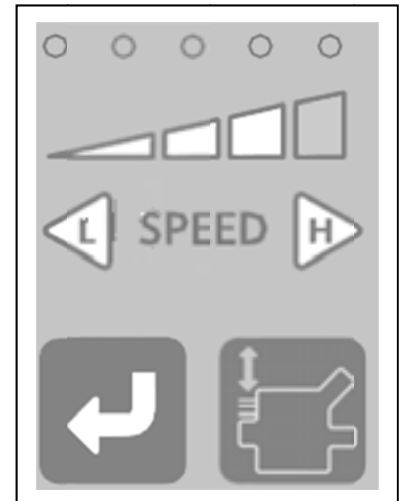

- 6) **Fit Paper Side Guides along the paper edges and tighten Two Thumb Screws.**



- 7) **IMPORTANT:**

**Leave no gap between Leading Edge of the Paper and Machine Front Stopper Wall. Such gap may cause paper skew.**

**Use Feed Table Skew Adjustment knob at Feed Table to Remove unnecessary gap between Paper Leading Edge and Machine Front Paper Stopper Wall.**

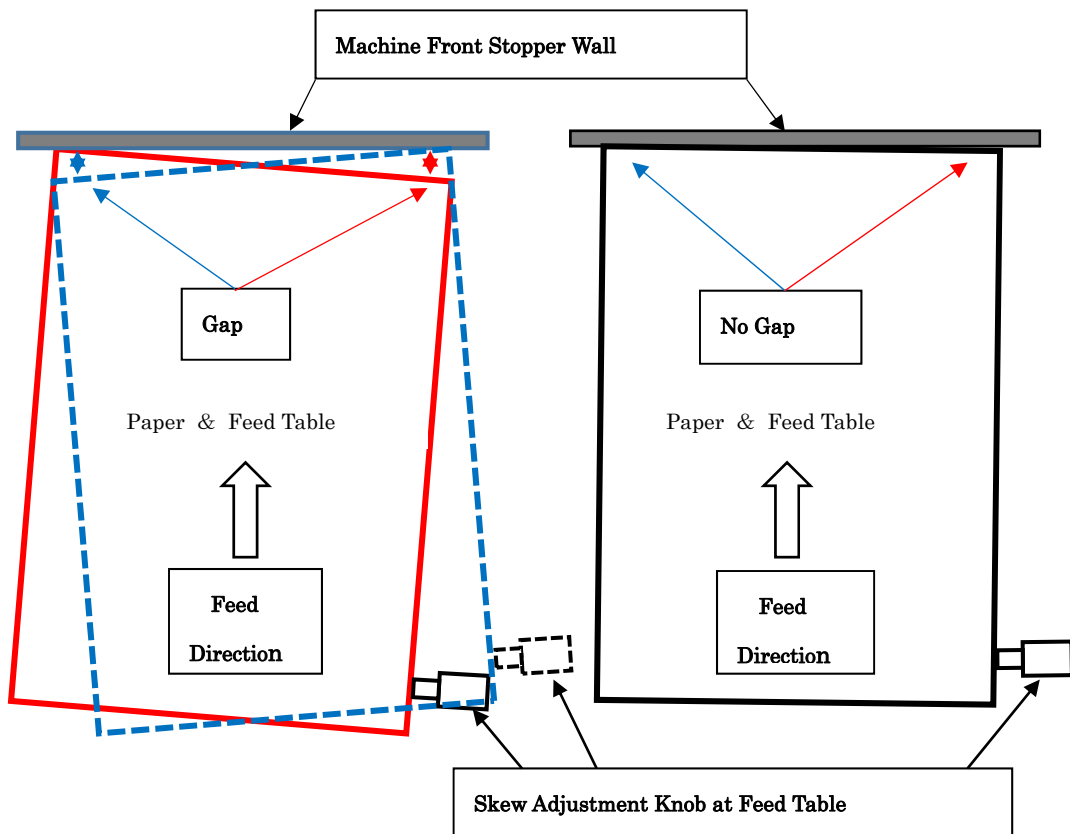

**8) Skew Correction is done by two methods.**

(a) By Feed Angle Adjustment Dial (by Drum-Feed-Roller)

For less than 34.3 lbs Bond paper, Feed Angle Adjustment Dial is used.

This method is used relatively lighter paper and fine adjustment.

Refer page 35 - 40 for each folding pattern.

Feed Angle Adjustment Dial

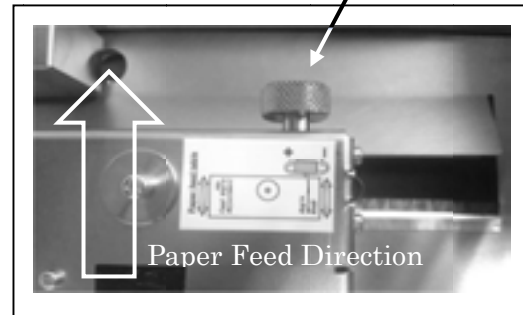
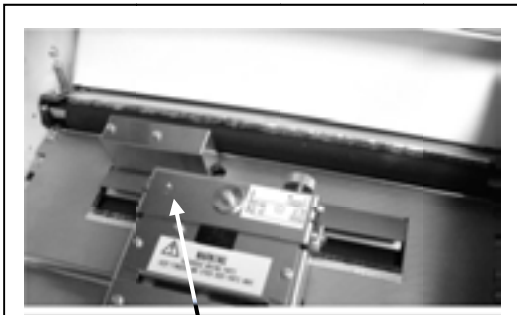

Refer Pin Window as guidance for original angle and adjusted angle.

(b) For over 34.3 lbs Bond paper, Skew Adjustment Knob at Feed Table

This method is used relatively heavier paper which cannot be controlled by Feed Angle Adjustment Dial. Also it is used for eliminating gap between paper and Machine Front Stopper Wall at first paper loading.

Refer Pin Window as guidance for original angle and adjusted angle.

Refer page 35 - 40 for each folding pattern.

Skew Adjustment Knob



Pin

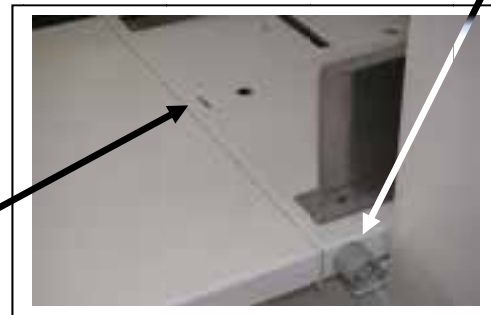

**9) Set L Stopper at the rear end of the Paper.**



**10) Close the Top Cover.**

**CAUTION:** For security, Top Cover should be closed holding by two hands.



# 11) Trial Air Blow, Trial Paper Floating and Trial Suction (Air Control)

## (a) Air Blow Strength Adjustment for sheet separation

(i) The air blow strength can be adjusted by turning the air adjustment knob from thin to high, i.e., weaker to stronger.

General Guidance:

When double feed occurs, turn the air adjustment knob toward weaker position slightly.

When paper is not fed, turn the air adjustment knob toward stronger position slightly.



Note: We do not encourage that you change position of Air Adjustment Knob extremely from the original position.

(ii) Trial Air Blow without feeding paper

To find if paper is separated properly for feeding, trial air blow can be done. Press Test Mode Key for more than 2 seconds until buzzer sounds. Then air starts to blow and Paper Feed Table rises without feeding paper.

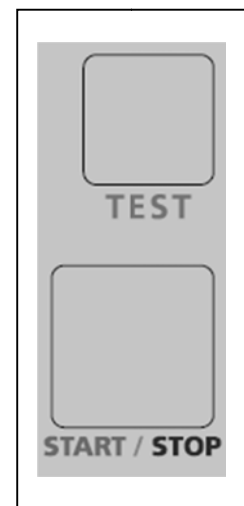

(iii) Adjust Air (Blow) Adjustment Knob so that the leading edge of top 5 to 7 sheets flies in the air with stability/steadily and without sticking two sheets together. Dial is set more or less at thin position (weaker blow) as picture right hand for Ledger(11" × 17"), 24lbs, Bond paper for practice.

Observe Top Leading Edge of Paper from both sides of paper stack.

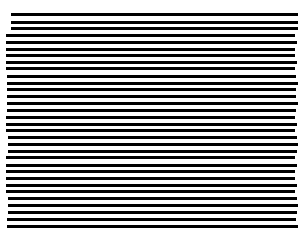
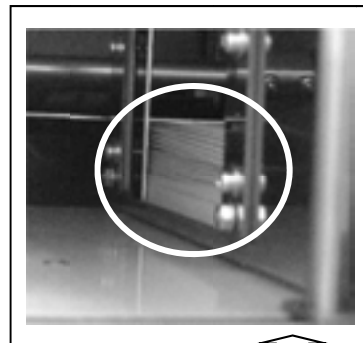
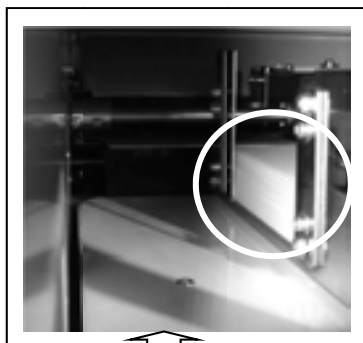

Not well separated.

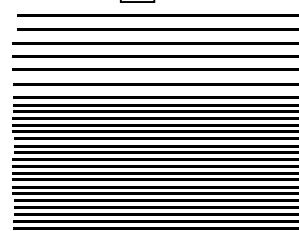

Good separation



(iv) Weight Arm for charging air between sheets

In case upper 5 – 7 sheets chatter, use of Weight Arm is effective. Refer paragraph 14-1, Weight Arm, page 51.

**(b) Paper Floating Height Adjustment relative to Suction Belt.**

Paper Floating Height and Strength of Air Blow are adjusted so that paper is fed consistently. For this practice of Ledger(11" × 17"), 24lbs, Bond paper, use position 2nd from THIN.

General Guidance:

Thicker paper or paper not easy to suck up, set for thicker position.

Thinner paper or paper tends to make double feed, set for thinner position.

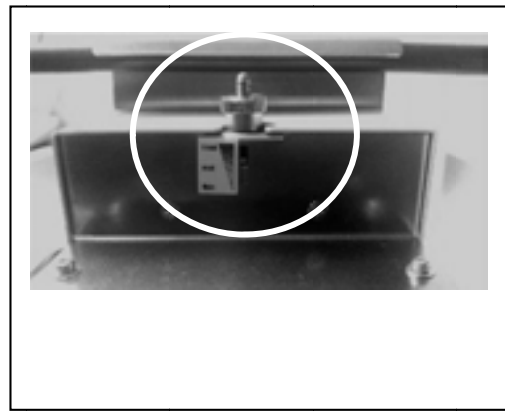

**(c) Adjustment of Suction Air Strength**

When folding thinner papers which tends to make double feed, adjust suction power lower. At thinner position, suction power is lesser. At thicker position suction power is stronger. In case frequent double feed is observed, slide, adjust and tighten the Dial at thinner position.

For Ledger(11" × 17"), 24lbs, Bond paper, position dial between thin and mid.

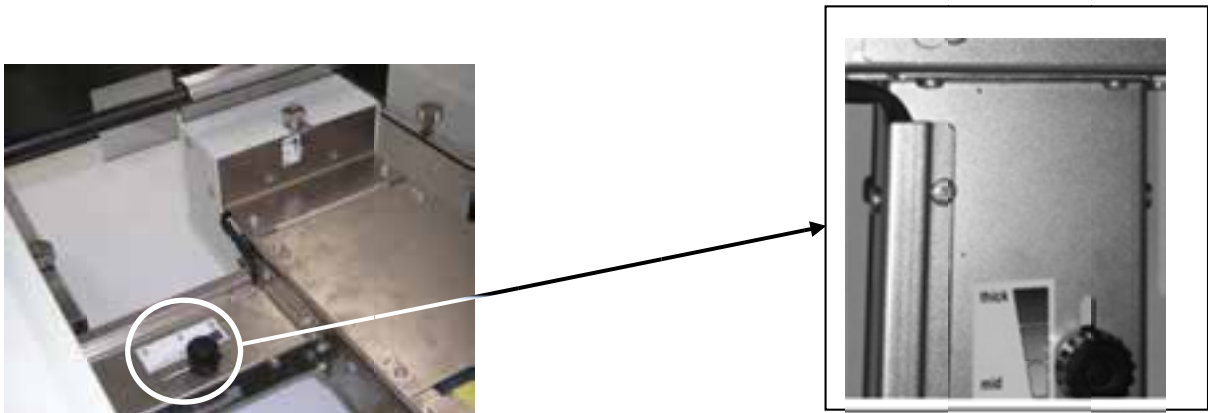

**(d) Approximate Guidance of Suction Air and Paper Feed Table Height**

Adjustment of Suction Air and Paper Feed Table Height depend on paper quality, print condition or other environment. So adjust them by referring to the following table as approximate guidance.

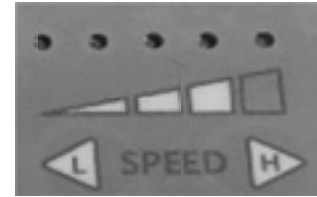
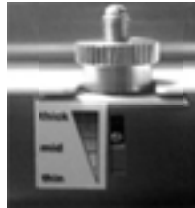

Blow Air Control

Paper Floating Height

Suction Control

Speed Control

6 Graduations (Linear)

5 Graduations (Linear)

5 Graduations (Linear)

5 Graduations (Linear)

1 ~ 6

1 ~ 5

1 ~ 5

1 ~ 5

	17 lbs	21.6 lbs	41.7 lbs	55.8 lbs	61.9 lbs
	Bond Paper	Bond Paper	Bond Paper	Bond Paper	Bond Paper
	Graduation	Graduation	Graduation	Graduation	Graduation
Blow Air Control	2	3	5	6	6
Paper Floating Height	2	3	4	5	5
Suction Control	2	3	4	5	5
Speed Control	1 ~ 3	1 ~ 4	1 ~ 5	3 ~ 5	3 ~ 5

**General Guidance:**

- In case Double Feed is frequently observed, set thinner side for appropriate control dial.
- In case Empty Feed is frequently observed, set thicker side for appropriate control dial.
- In case upper 5 – 7 sheets are chattering, use of Weight Arm is effective. Refer paragraph 14-1, Weight Arm, page 51.

## 12) Selection of Folding Pattern.

6 preset folding patterns, Single, Letter, Zigzag, Double Parallel, Fold-out and Gate, are available.

For this practice, select Single Fold and Key lights.

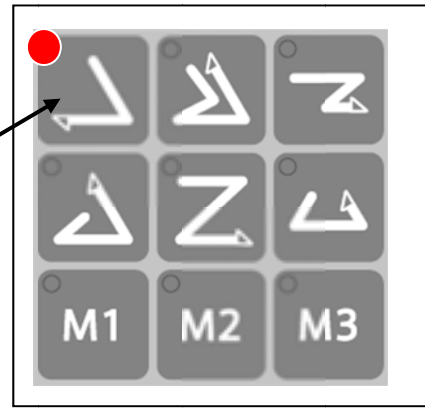

## 13) Selecting Folding Speed

Speed is adjustable in 5 steps by L Key and H Key. Speed is indicated by LED lamps, slowest in the extreme left and fastest in the extreme right. Medium speed is 3<sup>rd</sup> light from the left. Depending on paper quality, paper thickness and paper folding pattern, select adequate folding speed.

Note: In case folding thick paper, it may recommend to use faster speed. In case paper gets wrinkle, use slower speed.

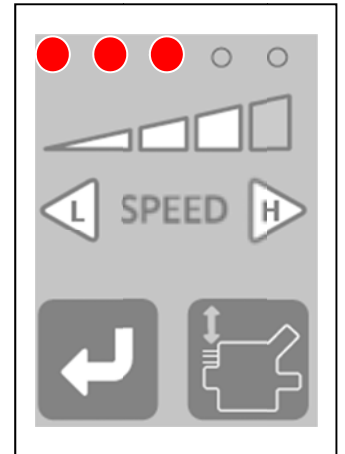

## 14) Setting Speed

In this practice, select Medium Speed by using L or H Key.

## 15) Test Folding

Press TEST Key and 2 sheets are folded in sequence without counting Counter. Examine 2<sup>nd</sup> folded sheet whether folded as desired.

Notes:

- (1) In case folding position is not as desired, adjust Position of Stoppers at Table 1 or Table 2 or both.  
Refer Stopper Adjustment in page 34.
- (2) In case skew is found, adjustment is necessary.  
Refer Skew Adjustment in page 35 through 40.
- (3) In case Double Feeding or Empty Feeding occur, adjustment of Separation Air Blow, Paper Floating Height or Suction Air Strength is necessary.  
Refer Air Adjustments in page 25 through 27.

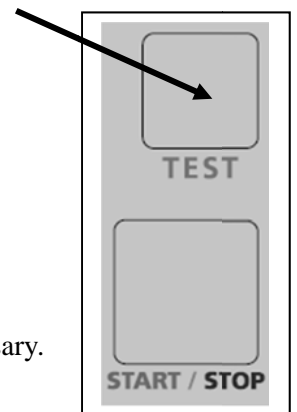

## 16) Other Controls and Functions

### (a) Adjustment of Paper Ejection Roller Location

Roller automatically sets at the preset position as long as paper size is standard norm. In case of Out of Standard Norm Paper, press Paper Ejection Roller Move Key. By pressing + or - Key, move the Roller and position where roller Effectively works for specific folds the paper size.

After position is selected, press Paper Ejection Roller Move Key again.

Depending folding speed and pattern, the Roller need to be relocated.

Smaller numeral shows location of Roller closer to machine body.

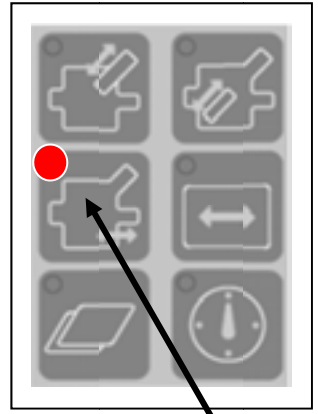

Paper Ejection Roller Key

### (b) How to Use Interval Function

(1) After selecting a fold type,

Press the Interval key.

The lamp on the Interval Key illuminates.

Interval Key

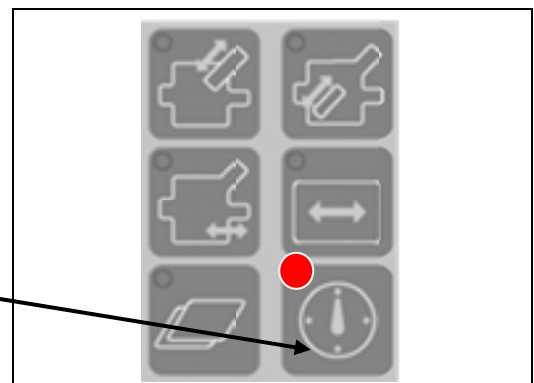

(2) The bar on the display right beside "SEC" flashes.

Using the numerical keys "1" or "10", input a desired interval time for intermittent operation.

\* 1 to 99 seconds can be set as the interval time.

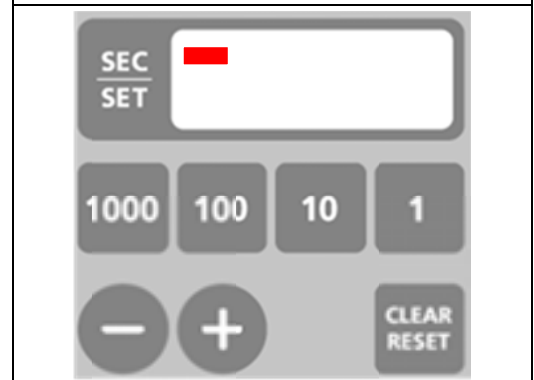

(3) Press the Interval key again.

The bar on the display right beside "SET" flashes.

Using the numerical keys "1", "10" or "100", input a desired number of sheets of paper to be folded for each interval.

\* 1 to 999 sheets can be set for interval operation.

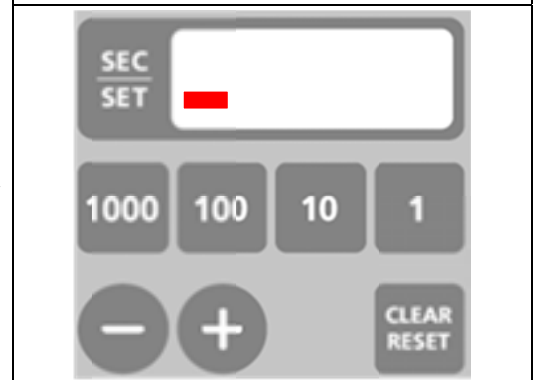

(4) Press the Interval key again.

Then, the lamp on the Interval key flashes indicating the working procedure is set.

(5) Press the TEST key or START key to start paper folding.

(When pressing the TEST key first, then the counter function is not effective, i.e, test sheets are not counted.)

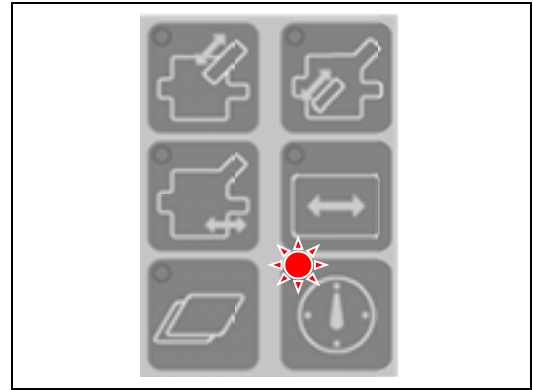

(6) How to clear Interval Mode

Press the Interval Key and press the Clear Key or input “0”. Then, the interval function is cleared.

### Example:

How to set 8 seconds as interval time and 50 sheets fold as number of sheets for interval operation.

By this setting, the machine will stop for 8 seconds after folding 50 sheets, and start folding again automatically.

### How to set:

- ① Press the Interval key.
- ② The bar beside “SEC” flashes. Using the numerical key, input “8”.
- ③ Press the Interval key.
- ④ The bar right beside “SET” flashes. Using the numeral key, input “50”.
- ⑤ Press the Interval key. The lamp on the Interval key flashes.
- ⑥ Set the speed according to the paper quality and fold type.
- ⑦ After setting, press the TEST key or START key to start folding.
- ⑧ In case of making preset number of folds with the Interval function is set, input the desired preset number while the lamp on the Interval key is flashing. Then, the machine stops after the preset number of sheets of paper are processed.

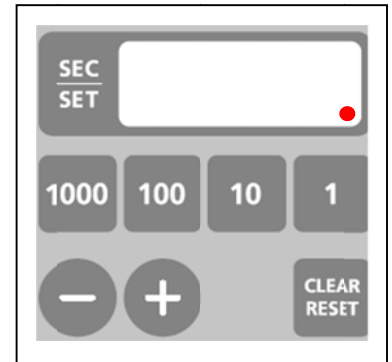

Note: when the dot below the units digit is lit, it shows that the preset value is input and valid.

When it is not lit, it is not valid and the machine continues to process until there is no paper loaded on the paper feed shelf.

### (c) Double Feed Detection or No-Detection

Detection Activated: Light is ON.  
Detection De-Activated: Light is OFF.

In case double feed is detected, machine stops. The double fed sheets are folded and exhausted but stays on the Output Paper Ejection Table. Counter un-counts the double fed sheets. Remove double fed sheets and clear Error Indication by Clear/Reset Key.

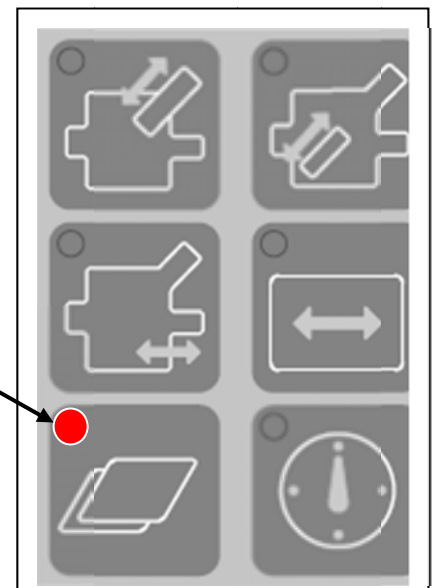

## 8. Standard folding of Standard-Size Paper

Follow instructions for machine and paper setting in Section 7-1)-(0) through 7-1)-(14)

### 1) Selection of Folding Pattern

6 preset folding patterns, Single, Letter, Zigzag, Double Parallel, Fold-out and Gate, are available.

### 2) Selecting Folding Speed

Speed is adjustable in 5 steps by L Key and H Key. Speed is indicated by LED lamps, slowest in the extreme left and fastest in the extreme right. Medium speed is 3<sup>rd</sup> light from the left. Depending on paper quality, paper thickness and paper folding pattern, select adequate folding speed.

Note: In case folding thick paper, it may recommend to use faster speed. In case paper gets wrinkle, use slower speed.

### 3) Setting Speed

In this practice, select Medium Speed by using L or H Key.

### 4) Set number of sheets to fold.

#### (a) Subtraction Counter Mode

For practice, here 100 sheets is to be fold. Press C Key to reset counter to 0 (zero). By number Key set 100. By one time press of 100 Number Key, its sets 100. By pressing twice, it sets 200.

In this subtraction counter mode, machine folds until counter become 0 (zero)

#### (b) Adding Up Counter Mode

If counter is set zero, machine folds until sheet is empty on Paper Feed Table.

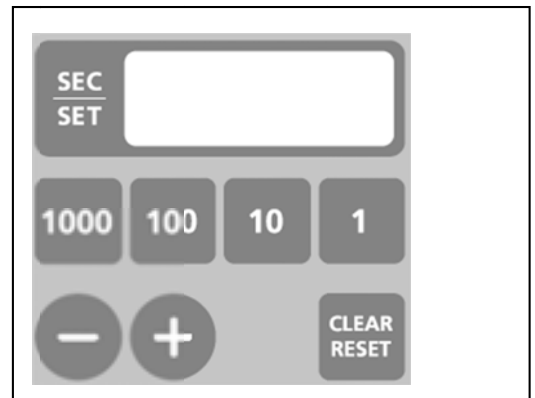
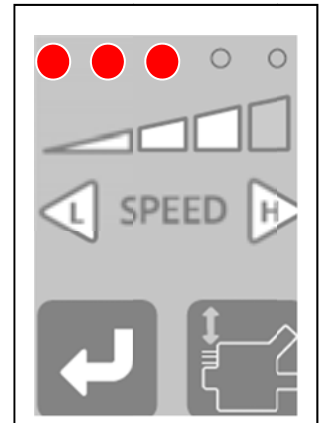
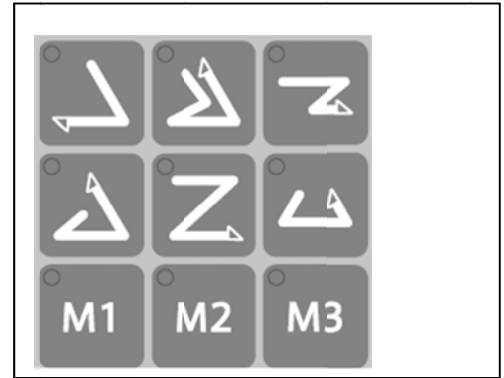

Note: when the dot below the units digit is lit, it shows that the preset value is input and valid. (Subtraction Counter Mode)

When it is not lit, it is Adding Up Counter Mode.

### 5) Start Folding

By pressing START/STOP Key, machine continues to fold paper. During folding operation, when START/STOP Key is pressed, machine stops folding. In case when START/STOP Key is pressed and machine restart and counter number is effectively continuous. Use Adding Mode or Subtracting mode depends on need.

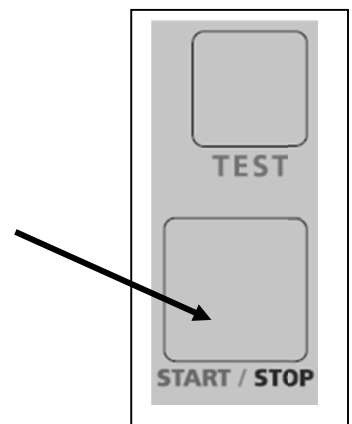

### 6) Folding Line (distance) Adjustment

Refer Section 8 (Control)-1) Fine Adjustment for folding distances by Table 1 or Table 2. Page 33 – 34.

## 9. Standard Folding of No-Standard-Size Paper

Selecting a fold type first and then input total paper length

### 1) Measure the paper length.

The arrow indicates the direction of paper feed.

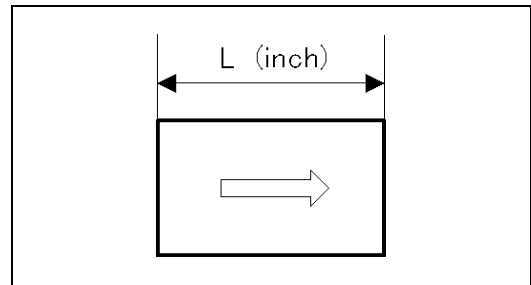

### 2) Press Paper Length Input Mode Key.

### 3) Input the paper length using the numerical keys.

The unit for input is inch.

For example: Input paper length of 11.42 inch

Press [1000] key 1 times. (Input unit of 10 inch)

Press [100] key 1 times. (Input unit of 1 inch)

Press [10] key 4 times. (Input unit of 0.1 inch)

Press [1] key 2 times. (Input unit of 0.01 inch)

Note: Units of numerical keys are higher by 10 times than the unit of length

The available input range is 13.0 to 19.25inch .

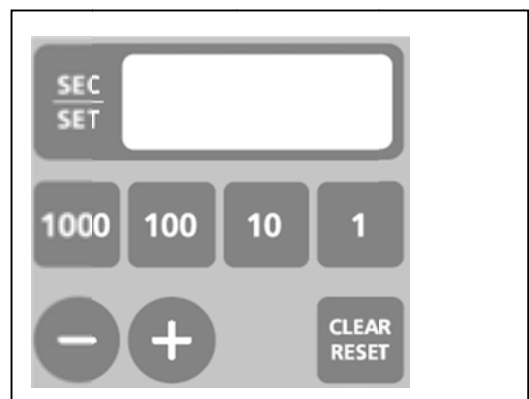
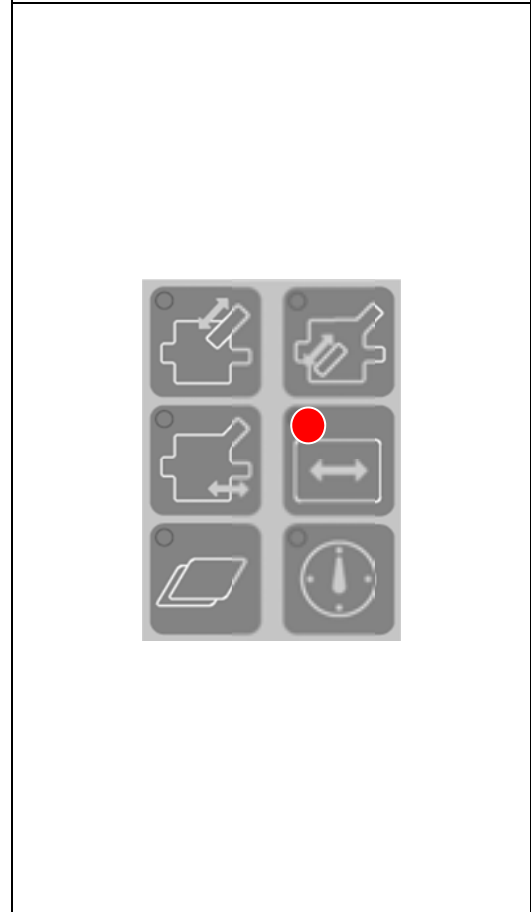

4) After the length is set, press the Paper Length Input Mode Key again to fix it. When any value out of standard length from machine specifications is input, the lamp flashes. To clear the input value, press the Length Input Mode key and then press the “C” key.

**5) Paper Preparation, Paper Setting, Speed Selection, Air Control and Feed Table Skew Control are the same procedures as Standard Folding of Standard Norm Paper.**

Refer pages 20 – 28 and 33-40.

**6) Set number of sheets to fold.**

a) Subtraction Counter Mode

For practice, here 100 sheets is to be fold.

Press C Key to reset counter to 0 (zero).

By number Key set 100. By one time press of 100 Number Key, its sets 100. By pressing twice, it sets 200.

In this subtraction counter mode, machine folds until counter become 0 (zero)

b) Adding Up Counter Mode

If counter is set zero, machine folds until sheet is empty on Paper Feed Table.

**7) Start Folding**

By pressing START/STOP Key, machine continues to fold paper. During folding operation, when START/STOP Key is pressed, machine stops folding. In case when START/STOP Key is pressed and machine restart and counter number is effectively continuous. Use Adding Mode or Subtracting mode depends on need.

**8) Folding Line (distance) Adjustment**

Refer Section 8- 1) Fine Adjustment for folding distances by Table 1 or Table 2. Page 33 – 34.

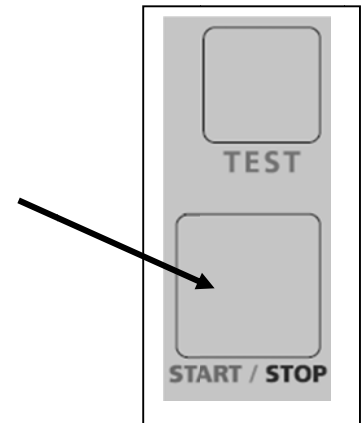



## 10. Control (Adjustments)

### 1) Fine Adjustment for folding distances by Table 1 or Table 2

Select the Stopper Move Mode key (Table 1 or 2). The lamp of the selected Stopper Move Mode key illuminates. The current stopper position is shown on the [Counter]. In case of standard-size paper, the stopper moves automatically to the suitable position according to the paper size and fold type. Apply this adjustment when fine adjustment is in need for the folding position. Values input manually return to standard values if any one of other fold type keys is pressed.

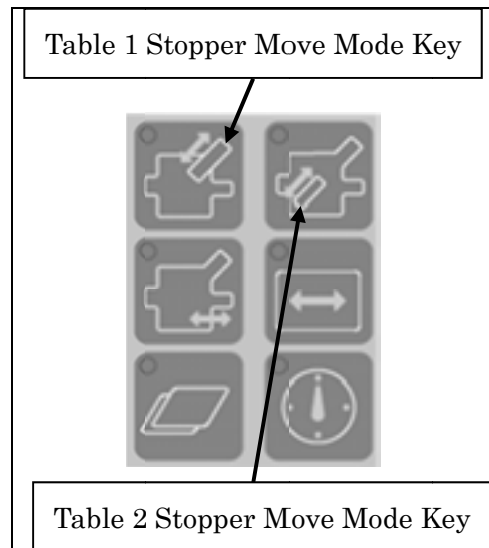

Press the +/- key and move the stopper to the desired position. The value displayed on the [Counter] shows the position of the stopper. (Unit: mm)

Example: When display of the [Counter] is 11.38", the stopper position is 11.38 inch.

The position can be moved based on a unit of 0.003 inch.

Press the Stopper Move Mode key (Table 1 or 2) again.

The lamp on the Stopper Move Mode key flashes.

Refer table for adjustment at page 34.

Folding positions of sheet are determined by the Stoppers positions of Table 1 and 2.

Double arrowed line (  $\longleftrightarrow$  ) shows the length the sheet is folded by the specific Table.

Example, In case of Double Parallel,

Table 1: Fold a half of the overall length

Table 2: Fold one fourth of the overall length

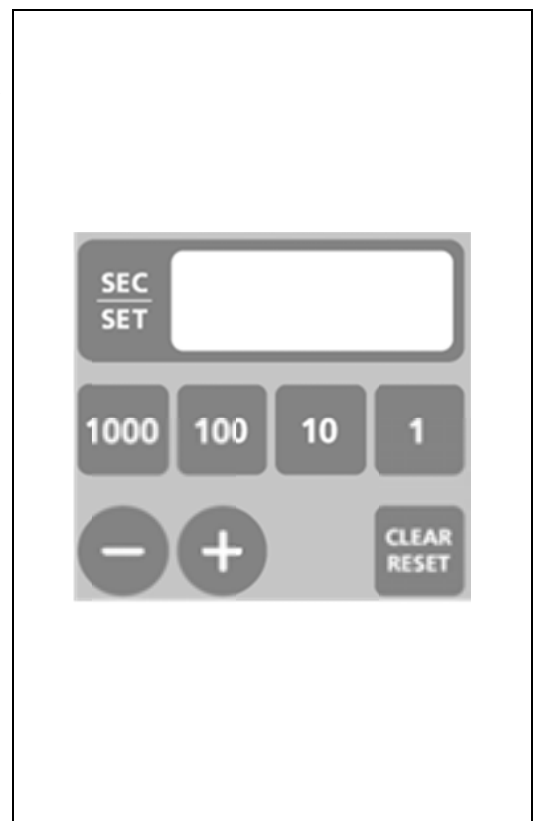

Note: In case of Single Fold Key is pressed, machine automatically let Interceptor Push Bar go down and push Interceptor, i.e., Table 1 is closed by Interceptor and it by-pass folding sheet to Table 2.

In this case, even Table 1 Stopper Move Mode Key is pressed and + or – Key is pressed, Interceptor Push Bar does not come down to contact with Interceptor. This avoids accidental bending of Interceptor Push Bar.

Note: Folding position may change depending on humidity, temperature, paper stretches or shrinking.



In that case, do fine adjustment for Table 1 or Table 2.

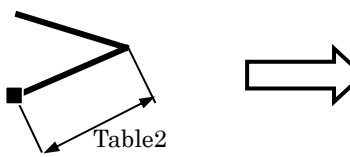
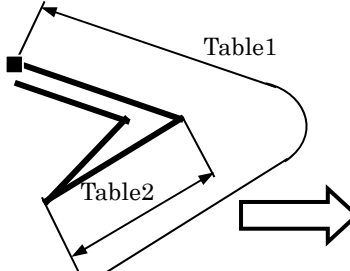
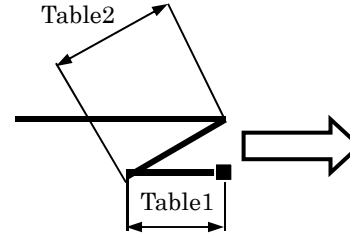
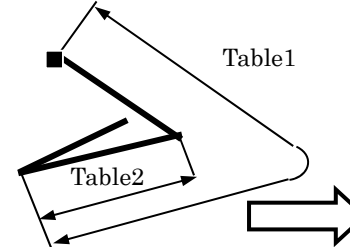
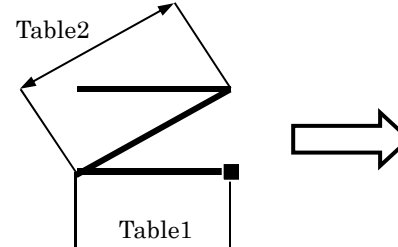
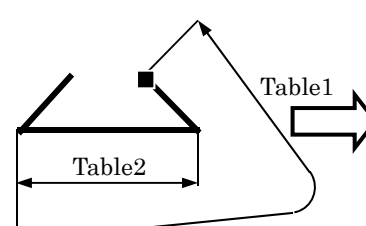



2) Stopper position guide of Table 1 or Table 2 for each fold type

	Fold Type	Table1	Table2
SINGLE		—	1/2
DOUBLE PARALLEL		1/2	1/4
FOLD-OUT		1/4	1/4
LETTER		2/3	1/3
ZIGZAG		1/3	1/3
GATE		3/4	1/2

 Feed Out Direction of Folded Paper

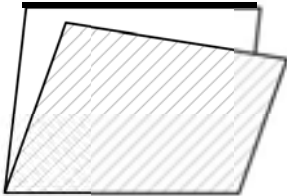
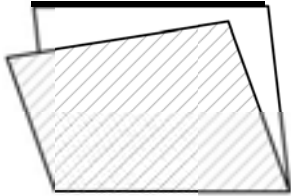
### 3) Skew Control Guidance Chart for 6 fording patterns by Feed Angle Adjustment Dial and by Feed Table Angle.

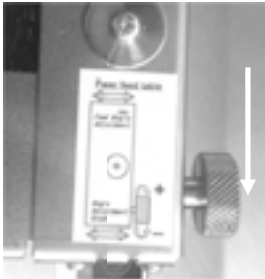
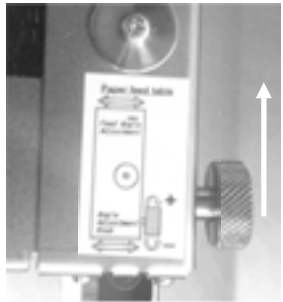

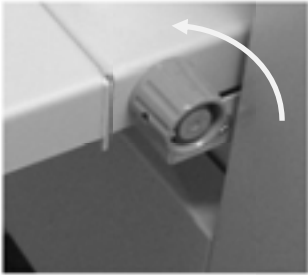
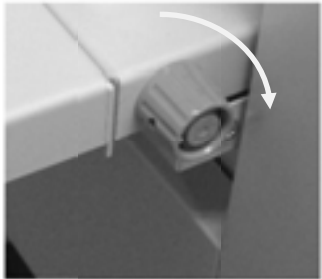
Skew Adjustment by folding pattern  Bold line indicates leading edge when paper is place on feed try.  
 Shadow indicates upper surface when paper is on feed tray.



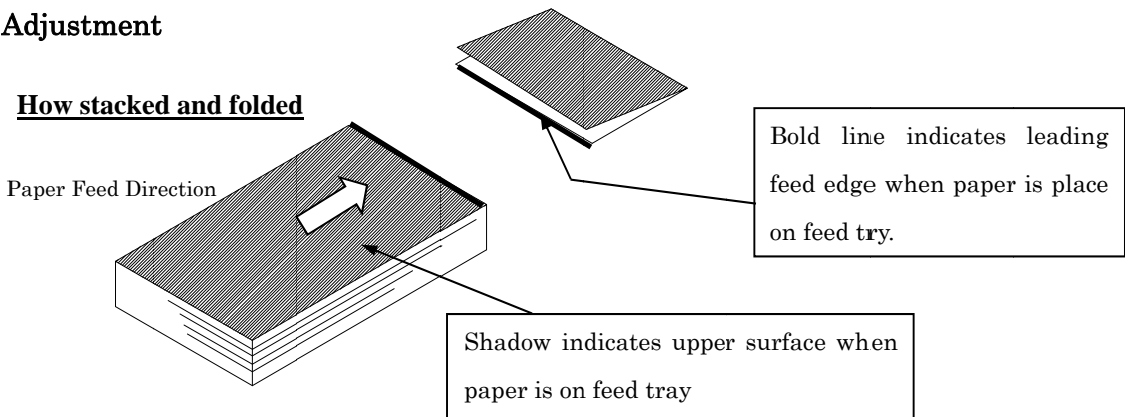

Fold Type	1) Single	
Skew		
Feed Roller Direction Adj. Dial ( <u>Less than 34.3 lbs Bond</u> )	Turn Metallic Thumb Screw Counterclockwise (-)	Turn Metallic Thumb Screw Clockwise (+)
		
Skew Adj. Knob ( <u>More than 34.3 lbs Bond</u> or <u>Feed Roller Direct. Adj. Dial is not effective</u> )	Turn Thumb Screw Counterclockwise	Turn Thumb Screw Clockwise
		

**NOTE:** Do not use, at the same time, Feed Roller Direction Dial and Skew Adjustment

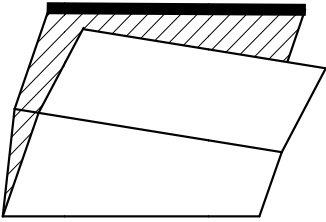
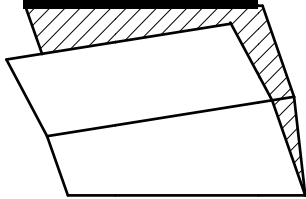

Skew Adjustment by folding pattern

 Bold line indicates leading edge when paper is place on feed try.  
 Shadow indicates upper surface when paper is on feed tray.

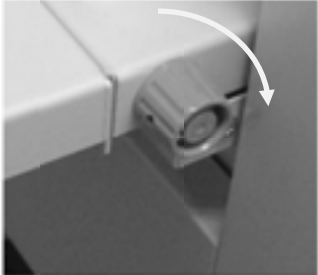
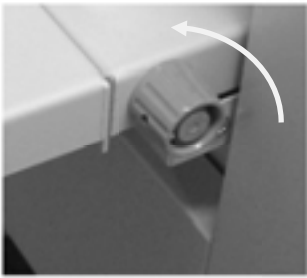
Fold Type	2) Double Parallel	
Skew		
Feed Roller Direction Adj. Dial ( <u>Less than</u> <b>34.3 lbs Bond</b> ) 	Turn Metallic Thumb Screw Clockwise (+) 	Turn Metallic Thumb Screw Counterclockwise (-) 
Skew Adj. Knob ( <u>More than 34.3 lbs Bond</u> or <u>Feed Roller Direct. Adj.</u> <u>Dial is not effective</u> ) 	Turn Thumb Screw Clockwise 	Turn Thumb Screw Counterclockwise 

**NOTE:** Do not use, at the same time, Feed Roller Direction Dial and Skew Adjustment Knob unless really needed.

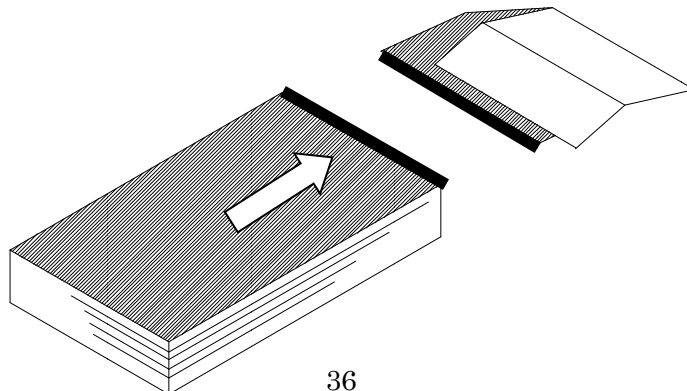





Skew Adjustment by folding pattern



Bold line indicates leading edge when paper is place on feed

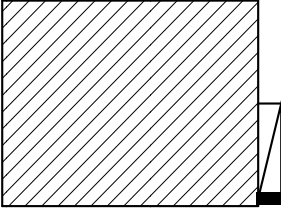
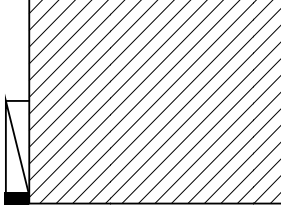

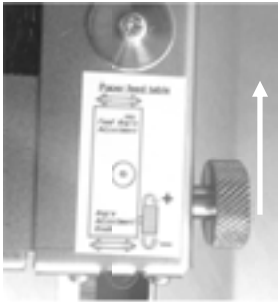
Shadow indicates upper surface when paper is on feed tray.

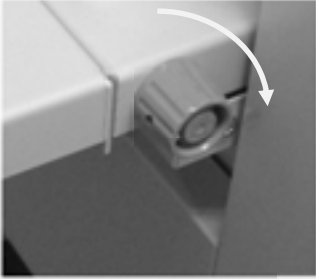
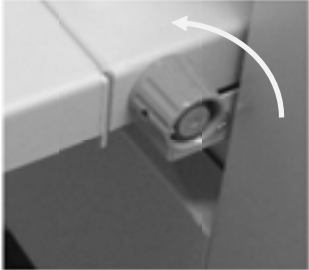

Fold Type	3) Fold-out	
<p>Skew</p>		
<p>Feed Roller Direction Adj. Dial (<u>Less than 34.3 lbs Bond</u>)</p> 	<p>Turn Metallic Thumb Screw Clockwise (+)</p> 	<p>Turn Metallic Thumb Screw Counterclockwise (-)</p> 
<p>Skew Adj. Knob (<u>More than 34.3 lbs Bond</u>) or <u>Feed Roller Direct. Adj.</u> <u>Dial is not effective</u>)</p> 	<p>Turn Thumb Screw Clockwise</p> 	<p>Turn Thumb Screw Counterclockwise</p> 



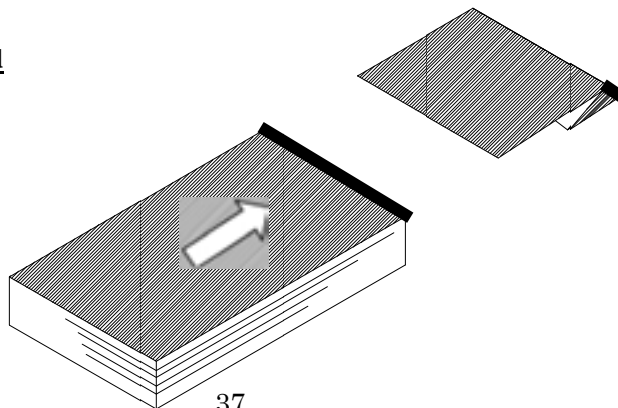

**NOTE:** Do not use, at the same time, Feed Roller Direction Dial and Skew Adjustment

How stacked and folded

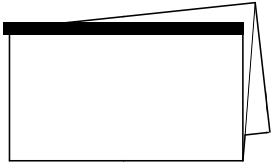
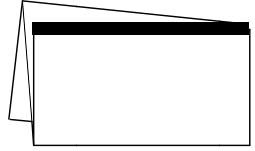

Skew Adjustment by folding pattern

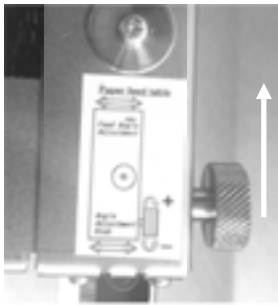
-  Bold line indicates leading edge when paper is place on feed
-  Shadow indicates upper surface when paper is on feed tray.

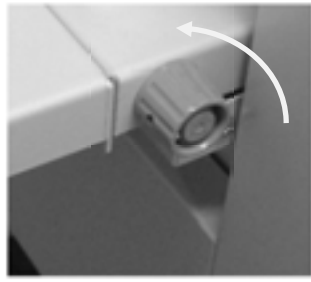
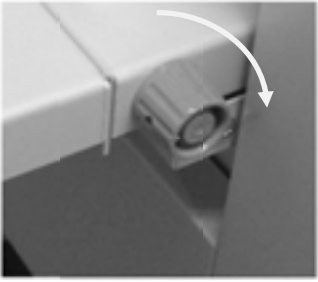
Fold Type	4) Letter	
Skew		
Feed Roller Direction Adj. Dial ( <u>Less than 34.3 lbs Bond</u> ) 	Turn Metallic Thumb Screw Counterclockwise (-) 	Turn Metallic Thumb Screw Clockwise (+) 
Skew Adj. Knob ( <u>More than 34.3 lbs Bond or Feed Roller Direct. Adj. Dial is not effective</u> ) 	Turn Thumb Screw To the Left 	Turn Thumb Screw To the Right 

**NOTE:** Do not use, at the same time, Feed Roller Direction Dial and Skew Adjustment

How stacked and folded

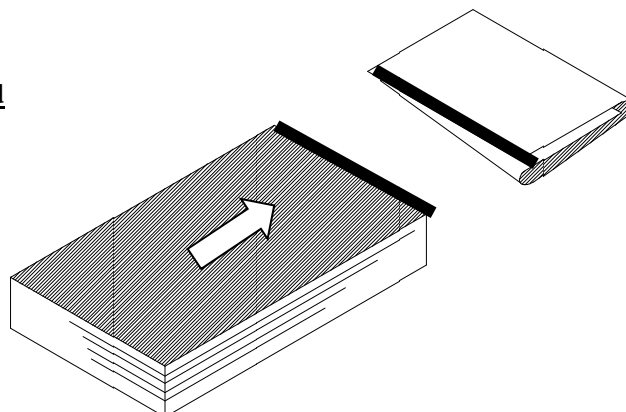



Skew Adjustment by folding pattern



Bold line indicates leading edge when paper is place on feed tray.

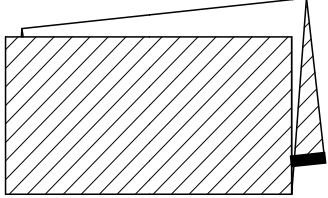
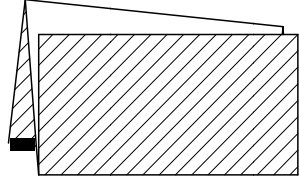

Shadow indicates upper surface when paper is on feed tray.

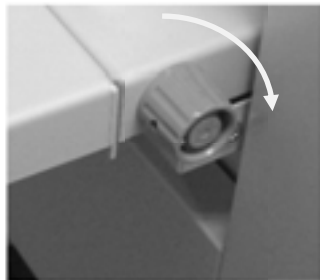
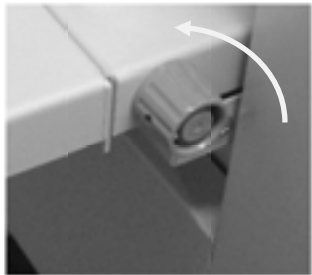
Fold Type	5) Zigzag	
Skew		
Feed Roller Direction Adj. Dial ( <u>Less than 34.3 lbs Bond</u> )	Turn Metallic Thumb Screw Clockwise (+) 	Turn Metallic Thumb Screw Counterclockwise (-) 
Skew Adj. Knob ( <u>More than 34.3 lbs Bond</u> or <u>Feed Roller Direct. Adj.</u> <u>Dial is not effective</u> )	Turn Thumb Screw Clockwise 	Turn Thumb Screw Counterclockwise 

**NOTE:** Do not use, at the same time, Feed Roller Direction Dial and Skew Adjustment

How stacked and folded

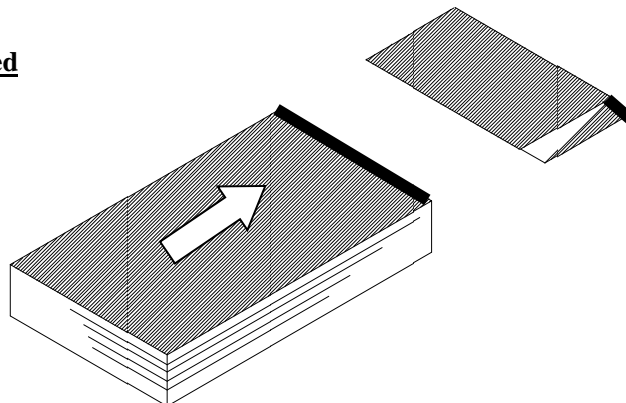





Skew Adjustment by folding pattern

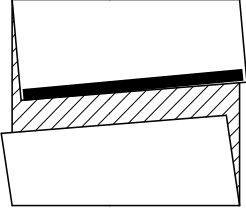
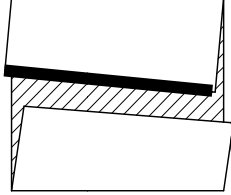

Bold line indicates leading edge when paper is place on feed try.

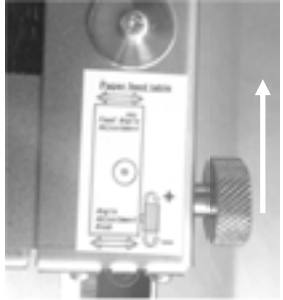
Shadow indicates upper surface when paper is on feed tray.

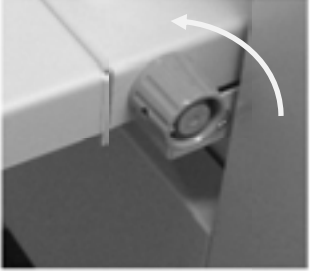
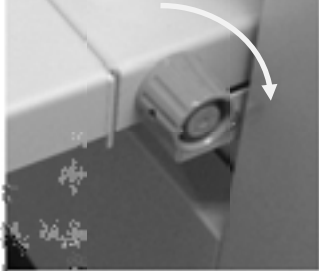
Fold Type	6) Gate	
Skew		
Feed Roller Direction Adj. Dial ( <u>Less than 34.3 lbs Bond</u> )	Turn Metallic Thumb Screw Counterclockwise ( - ) 	Turn Metallic Thumb Screw Clockwise ( + ) 
Skew Adj. Knob ( <u>More than 34.3 lbs Bond</u> or <u>Feed Roller Direct. Adj. Dial is not effective</u> ) 	Turn Thumb Screw To the Left 	Turn Thumb Screw To the Right 

**NOTE:** Do not use, at the same time, Feed Roller Direction Dial and Skew Adjustment

How stacked and folded

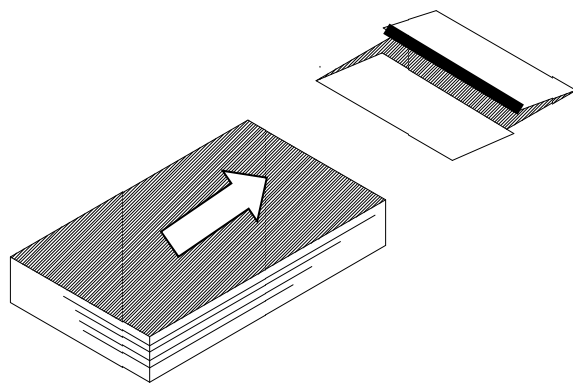



#### 4) Separator Rubber Height Adjustment

When adjusting the separator height, turn the separator adjustment knob using a flathead screwdriver. Adjust the height so that the tip of the separator rubber touches the paper feed belt slightly.

If double feed frequently occurs, gap between the Paper Feed Belt and Separator narrower.

If empty feed frequently occurs for thick paper, open about a 0.5mm gap between the Paper Feed Belt and Separator Rubber. Use several sheets of paper for filler gauge.

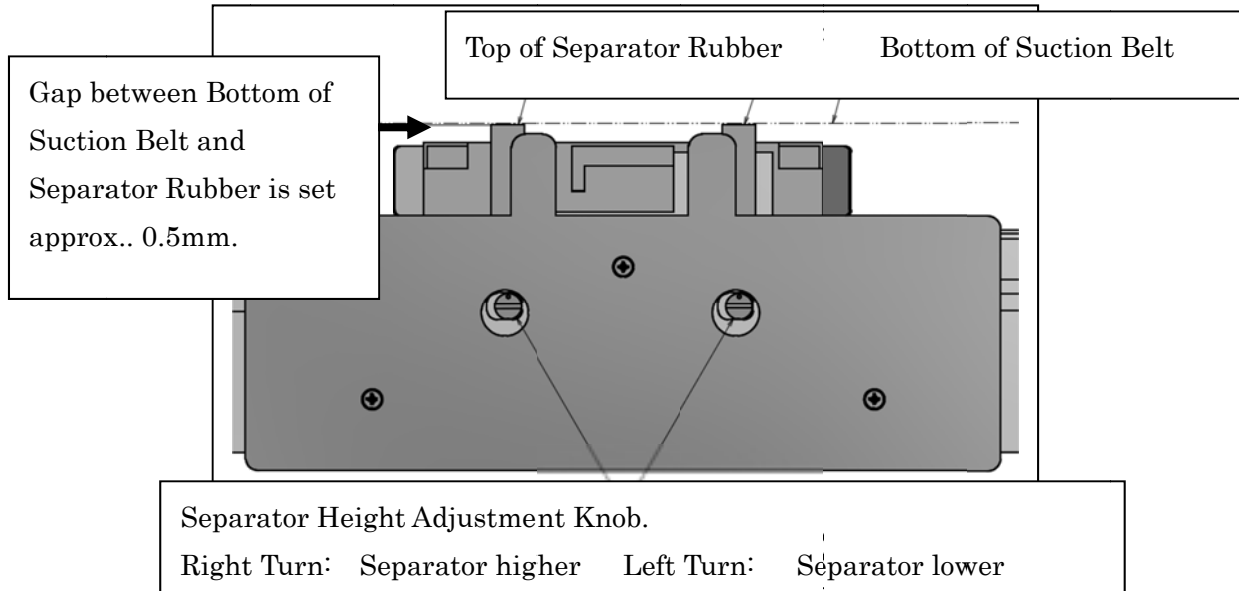

By turning the Separator Height Adjustment Knob clockwise, the separator raises to direction of paper feed belt. By turning the Separator Adjustment Knob counterclockwise, the separator comes down to opposite direction of paper feed belt.

## 11. Memory

### 1) Fold Position Memory of No-Standard Sized Papers

Non-standard folds setting can be stored by the memory M1/M2/M3 keys.

The positions of the stoppers of the Tables 1, 2, position of the ejection roller, and folding speed are, as a set, saved in a memory.



Input desired length of folding position and select the Memory Key, M1, M2 or M3, in which the fold is intended to be stored.

Press the Store Key and release immediately after a beep sound.

The lamp of the key in which the fold pattern has been memorized will flash.

Memory remains storing specific setting even main Power Switch is turned off, i.e., when Power Switch is turned on again, memorized pattern can be used again.

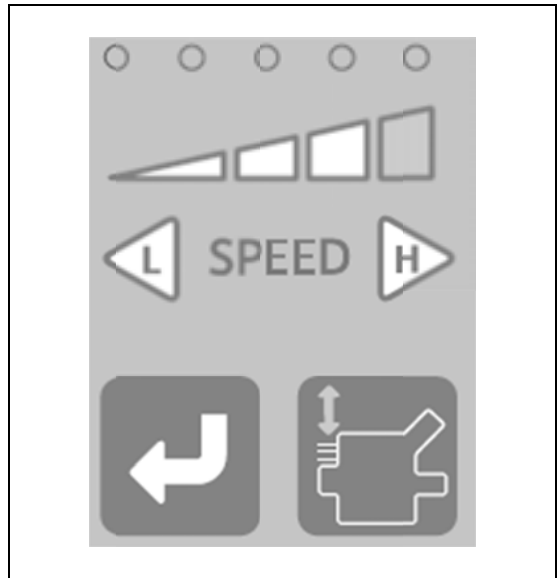

## 2) Fold Position Memory of Standard Sized Papers

In case desired to adjust folding position, after fine adjustment, adjusted folding position can be memorized at the folding pattern key. 3 paper size between Ledger thru Letter, 6 kinds of folding pattern can be allocated. That is 18 (= 3x6) kinds of fine adjusted value can be memorized.

The positions of the stoppers of the Tables 1, 2, position of the ejection roller, and folding speed are, as a set, saved in a memory.



After fine adjustment of fold positions, press the Store Key and release immediately after a beep sound.

(Regarding fine adjustment method, refer to Adjusting Table 1 or Table 2 of Page 34.

The lamp of the key in which the fold pattern has been memorized will flash.

Note:

By this setting method, out of standard folding pattern for standard sized paper can be memorized.

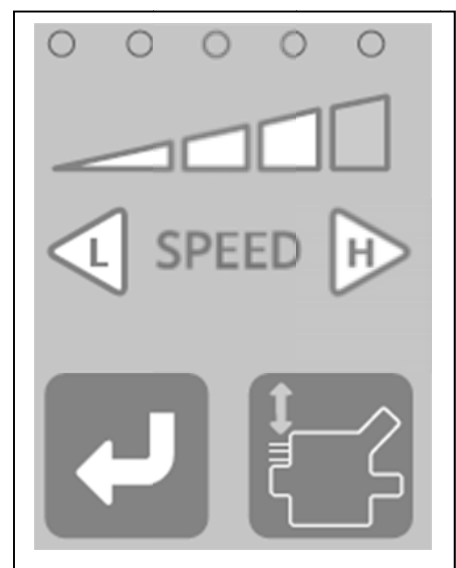

### 3) Clearing Memory

How to clear the memory storage in M1/M2/M3 keys and the fold type keys

Press first a desired Memory M1/M2/M3 Key or Fold Type Key being stored. Then keep pressing the C Key and release immediately after a beep sound.

The lamp of the key in which the storage has been cancelled will light.

Note:

The lamp of the key in which the fold pattern is currently stored flashes.

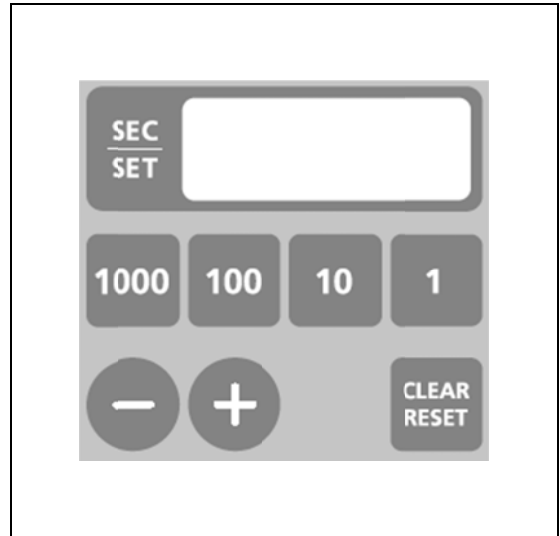

### 4) Clearing all the memorized patterns, i.e., reset to factory default.

Turn off the power first and then while pressing the Clear/Rest Key, turn on the power again.

Note:

All the stored pattern including custom fold you memorized are cleared. Give utmost attention because there is no chance to recall current memories after clearance.



## 12. Check Lamps, Error Codes and Troubles

### 1) If Check lamp (1) is flashing it may indicate:

- (1) Empty paper
- (2) Paper Feed Table is stack.
- (3) Failure of the Paper Height Sensor
- (4) Empty feed
- (5) Excessive loading of paper



### 2) If Check lamp (2) is flashing it may indicate:

- (1) Improper setting of Table 1
- (2) Stopper lock at Table 1

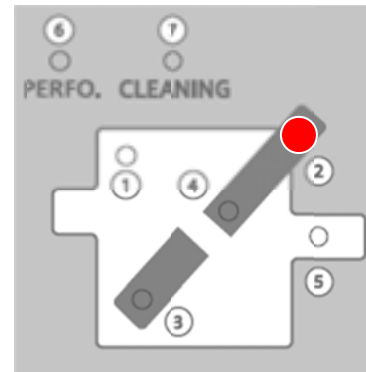

### 3) If Check lamp (3) is flashing it may indicate:

- (1) Electric plug of Table 2 is not inserted
- (2) Stopper lock of Table 2



### 4) If Check lamp (4) is flashing it may indicate:

- (1) Paper Jam



**5) If Check lamp (5) is flashing it may indicate:**

- (1) Electric plug of the Paper Ejection Unit is not inserted
- (2) Ejected paper is full
- (3) Ejected paper jamming.
- (4) Paper ejection sensor is dirty by dust or ink

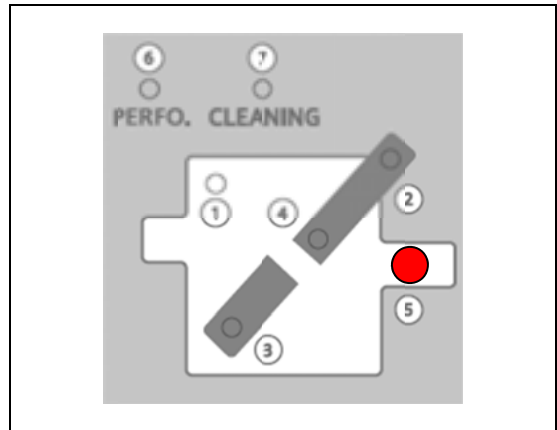

**6) If Check lamp (6) is lit, it may indicate:**

Perforator Unit (Optional) is installed

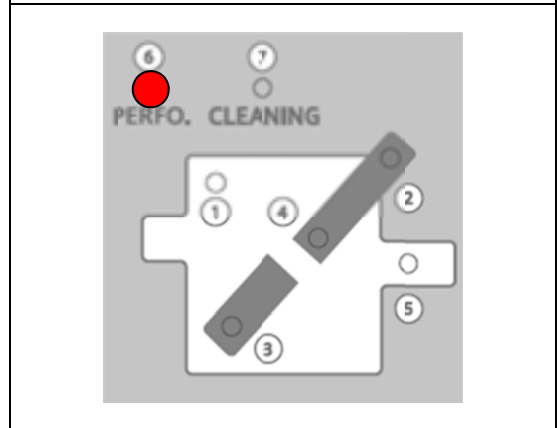

**7) If Check lamp (7) is lit, it may indicate:**

It lights after every 10,000 sheets of paper folded.

- For reset, turn on the machine while pressing – Key.
- You can disable this function when you turn on the machine while keep pushing [Single (Fold type)] key.
- You can activate this function again when you turn on the machine with [Gate(Fold type)] key pushed.

Clean the Paper Transport Belt as frequently as needed depend on the printing condition and paper quality even before the cleaning lamp is lit.

Regarding the cleaning method, refer to Cleaning of Sensors of page 38 and Cleaning of Fold Roller/Paper Feed Belt of Page 39.

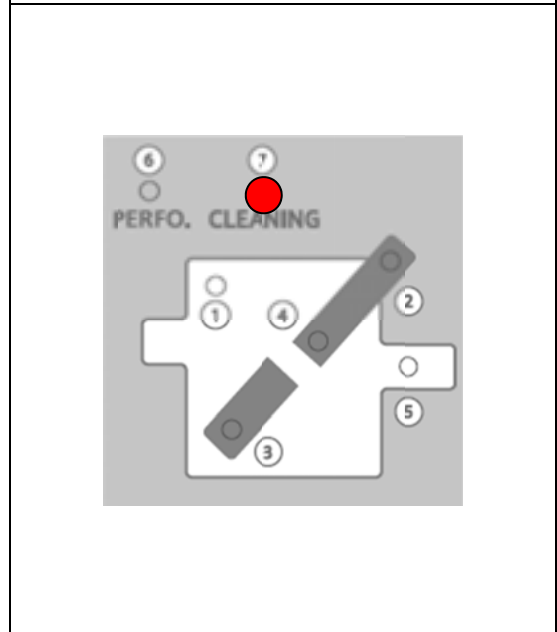

**Note:**

If paper is loaded immediately after printing, problems such as jamming, double feed, slipping, and wrinkling may occur. Make sure that the printing ink is completely dry, statics are gone and paper is well fanned out before loading.

If the machine is placed in the vicinity of a fluorescent lamp and the paper size detection sensor may not always function properly.

In such a case, place the machine away from the fluorescent lamp influence.

For each error symptom, the following error code will be displayed.

Error code	Symptom
E-01	No paper
E-02	Neither Table 1 nor Perforating/Scoring unit is installed to the position of Table 1 unit.
E-03	Paper left in Paper Ejection Sensor area, or Paper Ejection Sensor is dirty.
E-04	Internal paper jam
E-05	Ejected paper jam
E-06	Excessive loading of paper
E-07	Sensors need cleaning or Rollers need cleaning.
E-08	Paper Ejection Table Pluf is not connected.
E-09	Empty feed
E-10	Table 2 is not installed
E-11	Remove the Paper Ejection Table to use Perforator Unit.
E-12	Out of standard paper size, use Paper Length Manual Input Mode.
E-13	Double Feed Error. Remove Double Fed Paper from Ejection Table.
E-51	The door of the Table 2 is open, or Top Cover is open
E-52	Paper left in Paper Feed Sensor area, or Paper Feed Sensor is dirty.
E-53	Failure of Paper Height Sensor.
E-54	Failure of Feed Table Up and Down Motor
E-55	Failure of Main Motor, or the Encoder is dirty
E-56	Paper Ejection Roller is locked, or Motor Wire is disconnected, or Home Position Micro Switch for Ejection Roller is disconnected or dislocated.
E-57	At Table 1: Stopper is locked, or Stopper Motor is disconnected, or Sensor is disconnected.
E-58	At Table 2: Stopper is locked, or Stopper Motor is disconnected, or Sensor is disconnected.

**Note:** To clear Error Code from display, press CLEAR/RESET Key after cause of trouble is eliminated.

## 13. Troubleshooting and Cleaning

**CAUTION:** Make sure to disconnect power cable before starting the troubleshooting.

### 1) Troubleshooting of Paper jam

(1) Remove Table-1 and remove the paper or pieces of paper.



(2) Open Table-2 door, remove Table-2 and remove paper or torn pieces of paper.

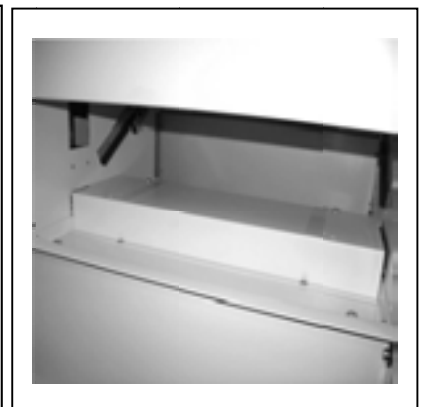
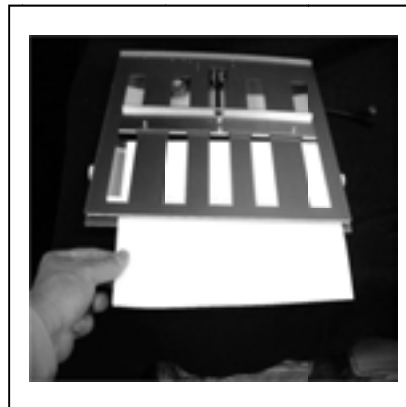
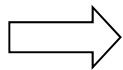

## 2) Cleaning of Sensors

Clean each location of Sensor periodically.

- (1) Open Top Cover and remove paper powder or dust by cotton swab, etc. from the window  
Circled position as shown in the following figure.

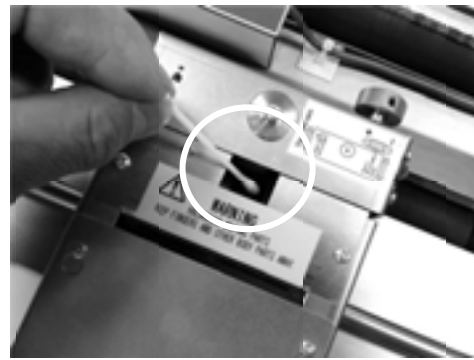

- (2) Clean Paper Eject Sensor (circled position as shown in the following figure) by cotton swab, etc.

(The paper eject sensor is transmission type. Bottom Sensor as seen in the Circle and Upper Sensor in metal casing above.) Clean both Lower and Upper Sensors. Especially note that Lower Sensor tends to get dust accumulated.

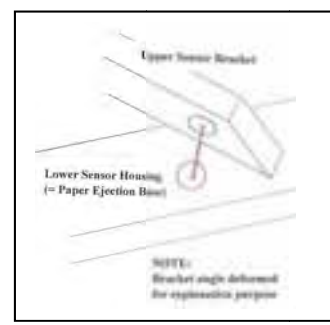
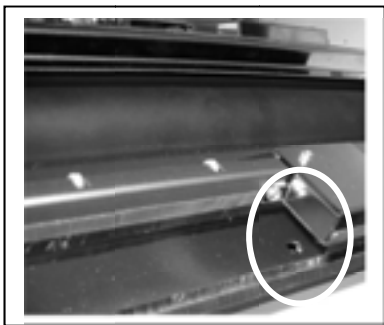

- (3) Clean Paper Detection Sensor by cotton swab. Locations of Sensor on the Paper Feed Table are circled.

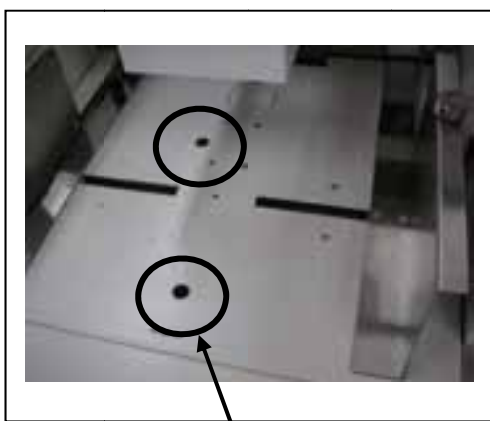

This additional sensor is for Inch (Imperial) type machine only.  
Metric type 1 Sensor.  
Inch type 2 Sensors.



### 3) Cleaning of Fold Roller and Paper Feed Belt.

When paper feed slips, folding line does not match as desired, wrinkled paper or inner paper jam occurs frequently, it may be caused from paper dust or ink accumulation on the rollers.

#### (1) Cleaning Folding Rollers

By removing one Folding Roller, other three Roller are accessible for cleaning without removing them from the machine.

Remove Folding Table 1 and Paper Ejection Table.

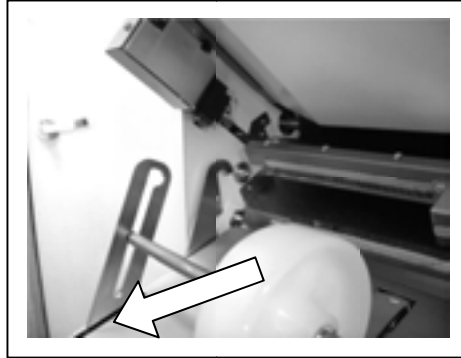
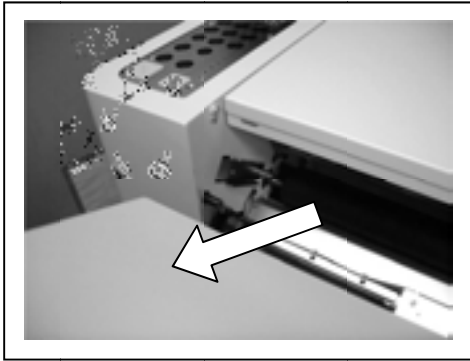

Lift Roller Fix Lever on both sides of Machine Frame.

Remove Press Roller As indicated below.

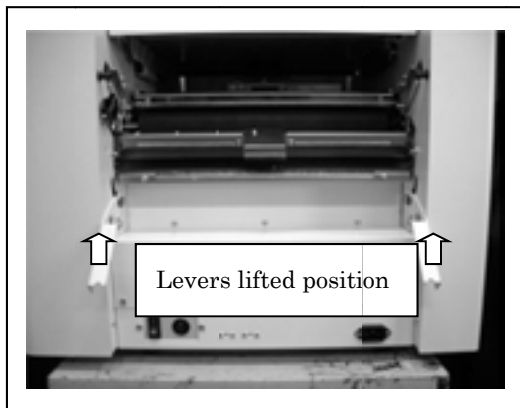

Press to left and then pull out.

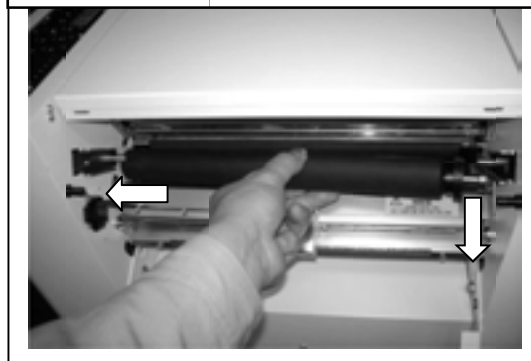

Clear paper dust and dirt on each Roller. Re-install the Rollers in reverse procedures. For installing Folding Roller, turn the Roller for 2 to 3 times so that the Roller Gears positively engage each other.



After roller is reinstalled, push down Roller Fix Lever on both sides of Machine Frame.

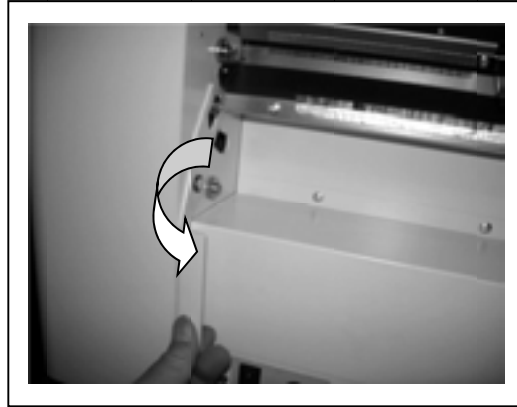

(2) Cleaning Suction Belt

Open Top Cover and loosen 4 screw of Suction Belt Cover.

CAUTION: PAY UTMOST CARE SO THAT SCREWS DON'T DROP IN THE MACHINE.

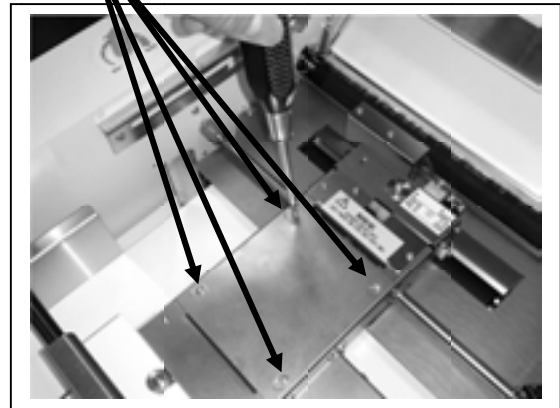
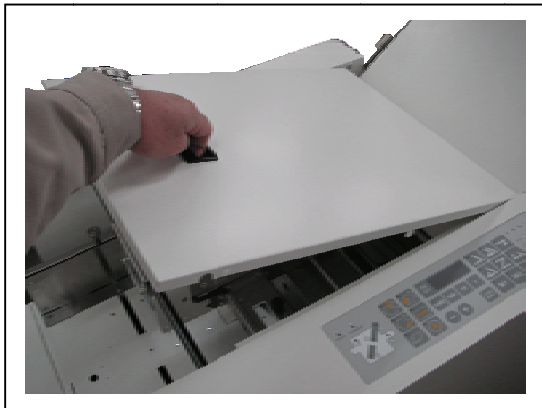

Remove Suction Belt Cover and clean the Belt by rotating it. After cleaning, fix Suction Belt Cover.

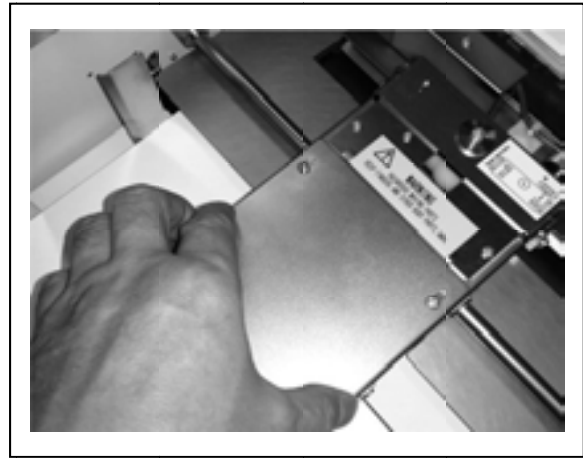

## 14. Other Adjustable Functions

CAUTION: Turn off the machine and remove Power Supply Cable from the electric outlet.

### 1) Weight Arm, Purpose of using Weight Arm

Weight Arm is used as supplemental tool for controlling air flow of sheet separation air. By placing it, separation air is charged within sheet pile so that good consistent sheet separation is available. It is especially effective for thinner papers.

A Weight Arm is supplied as a standard accessory. In case of no need, remove and keep it in a safe place.

Mount the Weight Arm pinching the holes on right and left side of the base. Weight Arm is spring loading type wire and mount the Weight Arm by slightly widening the opening. Mounting Holes are located No. 1, 2 and 3 positions. Try effectiveness of Weight Arm and choose the most effective Hole Position.

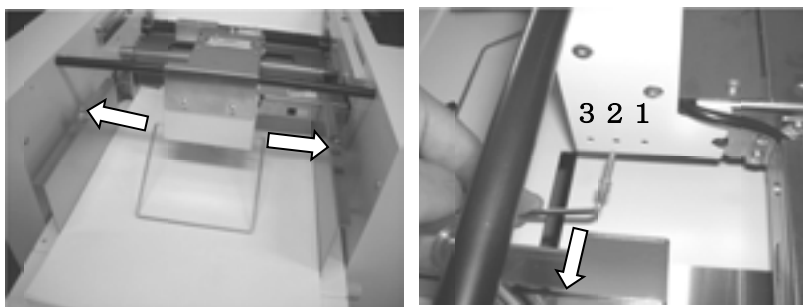

Mount Weight Arm by slightly widening it.

### 2) Adjustment of Base Plate of Table 2.

Position of Base Plate of Table 2 is adjustable back and forth.

As factory default setting, it is placed at 2rd hole (medium position).

General Guidance:

**Thicker Paper:** In case frequent slippage of paper is observed, remove Base Plate Fixing Screws located both sides of Table 2. Place the Base Plate for Thicker side of location and fix the Screws.

**Thinner Paper:** In case two-stage folding is observed, remove Base Plate Fixing Screws located both sides of Table 2. Place the Base Plate for Thinner side of location and fix the Screws.

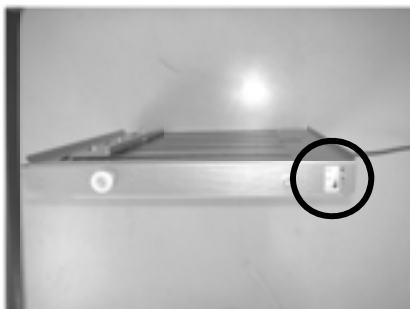

### 3) Folding Roller Pressure (Press Power) Adjustment

Folding Pressure can be set for 3 steps.

As factory default setting, it is place at mid. position.

Note: Adjustment should be done after Paper Feed Table is lifted at the highest position first.

Open Cover for Table 2 under Paper Feed Table.

Thicker Paper: In case higher folding pressure is desired, remove Thumb Screw and push the Bracket so that Folding Roller Spring gives higher pressure to the Roller. Left and Right Setting should be the same strength.

Thicker Paper => Higher Pressure.

Thinner Paper: In case paper is wrinkled, remove Thumb Screw and pull the Bracket so that Folding Roller Spring gives lower pressure to the Roller. Left and Right Setting should be the same strength.

Thinner Paper => Lower Pressure

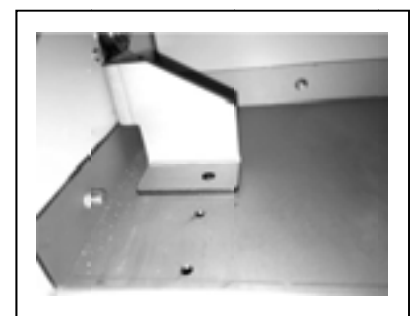
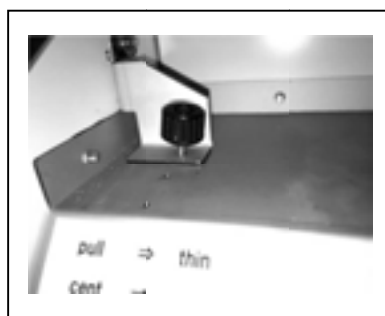
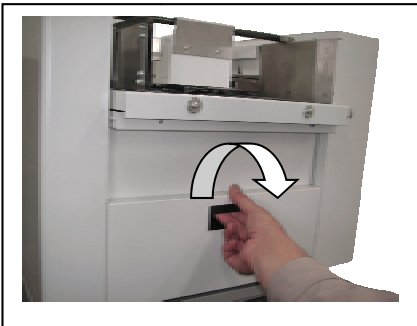

---- Memo ---

---- Memo ---

---- Memo ---

MBM Corporation